



Electro Industries/GaugeTech

DMMS300+, DMMS350 and DMMS425
3-Phase Multifunction Power Monitors
with Advanced Capabilities

Installation, Operation
and Programming Manual
Version 4.8/8-01

1800 Shames Drive
Westbury, New York 11590

Tel: (516) 334-0870 ● Email: sales@electroind.com
Fax: (516) 338-4741 ● Website: www.electroind.com

Electro Industries/GaugeTech
1800 Shames Drive Westbury, New York 11590 USA

Customer Service and Support

Customer service and support is available 9:00 A.M. to 4:30 P.M., ET, Monday through Friday. Please have the model, serial number and a detailed problem description available. If the problem concerns a particular reading, please have all meter readings available. For customer or technical assistance, **Phone: 516-334-0870 or Fax: 516-338-4741**

Product Warranty

Electro Industries/GaugeTech warrants all products to be free from defects in material, workmanship and title and will be of the kind and quality specified in EIG's written description in the manual. The foregoing shall apply only to failures to meet said warranties which appear within one year from the date of shipping. During the warranty period, EIG will, at its option, either repair or replace any product that proves to be defective.

Limitation of Warranty

This warranty does not apply to defects resulting from unauthorized modification, misuse or use for any reason other than electrical power monitoring.

OUR PRODUCTS ARE NOT TO BE USED FOR PRIMARY OVER-CURRENT PROTECTION. ANY PROTECTION FEATURE IN OUR PRODUCTS IS TO BE USED FOR ALARM OR SECONDARY PROTECTION ONLY.

THIS WARRANTY IS IN LIEU OF ALL OTHER WARRANTIES, EXPRESSED OR IMPLIED, INCLUDING ANY IMPLIED WARRANTY OF MERCHANTABILITY OR FITNESS FOR A PARTICULAR PURPOSE. EIG SHALL NOT BE LIABLE FOR ANY PENAL, INDIRECT, SPECIAL OR CONSEQUENTIAL DAMAGES ARISING FROM ANY AUTHORIZED OR UNAUTHORIZED USE OF ANY EIG PRODUCT. LIABILITY SHALL BE LIMITED TO THE ORIGINAL COST OF THE PRODUCT SOLD.

Statement of Calibration

Our instruments are inspected and tested in accordance with specifications published by an independent testing facility. The accuracy and a calibration of our instruments are traceable to the National Institute of Standards and Technology through equipment that is calibrated at planned intervals by comparison to certified standards.

Disclaimer

The information presented in this publication has been carefully checked for reliability; however, no responsibility is assumed for inaccuracies. The information contained in this document is subject to change without notice.

TABLE OF CONTENTS

CHAPTER 1: AC POWER	
MEASUREMENT	1
1.1: Single Phase System	1
1.2: Three-Phase System	2
1.3: Consumption, Demand and Poor Power Factor	3
1.4: Waveform and Harmonics	4
CHAPTER 2: MECHANICAL	
INSTALLATION	5
CHAPTER 3: ELECTRICAL	
INSTALLATION	7
3.1: Current Circuit	7
3.2: CT Connection	7
3.3: Voltage Circuit	8
3.4: Selecting the Voltage Fuses	8
3.5: Connection to the Main Power Supply	8
3.6: Electrical Connection Installation	8
3.7: Relay, Protection and Pulse Output	14
3.8: KYZ Pulse Outputs: NL2 Option	15
CHAPTER 4: COMMUNICATION	
INSTALLATION	17
4.1: RS-232C	17
4.2: RS-485	17
4.3: Network and Long Distance Communication	20
CHAPTER 5: OVERVIEW	23
5.1: Accessing the Power Functions	24
5.2: Accessing Voltage and Current Phases	24
5.3: Accessing %THD Functions	24
5.4: Viewing Individual Phase Indication for Power Functions	25
5.5: Accessing Max/Min Values	26
5.6: Resetting Values	26
5.7: Resetting Hour Readings	28
5.8: Accessing the LM1/LM2 Set Limits	28
5.9: Voltage Phase Reversal and Imbalance	29
5.10: Access Modes	30
5.11: Print Operating Data	30
5.12: Print Programming Data	31
5.13: Accessing Firmware Version/LED Test	31
CHAPTER 6: OVERVIEW	33
6.1: General Procedure	33
6.2: Switch Packs	33
6.3: Data Entry	34
6.4: Standard Numeric Data Entry	34
CHAPTER 7: DMMS425	35
7.1: DMMS MODEL COMPARISON	36
CHAPTER 8: ENTERING THE	
PROGRAMMING MODE	37
8.1: Checksum Error—Protective Self-Checking Algorithms	37
8.2: Password Entry	37
CHAPTER 9: PROGRAMMING GROUP 0:	
GLOBAL METER SETUP	39
9.1: Group 0, Function 0 The Integration Interval	39
9.2: Group 0, Function 1— The Meter Address	40
9.3: Group 0, Function 2— BAUD RATE	41
9.4: Group 0, Function 3— System Configuration	42
9.5: Modbus Plus Capability	44
9.6: Group 0, Function 3— Programming Procedure	45
9.7: Relay Mode	46
9.8: Group 0, Functions 4–5—Time Delay for Relays 1 and 2 (Option – NL)	49
9.9: Group 0, Function 6—KYZ Parameter Selection	51
9.10: Group 0, Function 7— Number of Phases	54

**CHAPTER 10: PROGRAMMING GROUP 1:
VOLTAGE, AMP AND WATT
SCALE SETTINGS.....55**

- 10.1: Group 1, Function 0—Full
Scale Voltage Settings, Scale
Factor & Decimal Point
Placement55
- 10.2: Group 1, Function 1—
Amperage Full Scale.....58
- 10.3: Group 1, Function 2—Scale
Selection and Decimal
Placement for Watts59

**CHAPTER 11: PROGRAMMING GROUP 2:
METER CALIBRATION.63**

- 11.1: Calibration Requirements63
- 11.2: Group 2, Functions 0—8—
High End Calibration of Voltage
Channels, High and Low End
Calibration of Amperage
Channels64

**CHAPTER 12: GROUPS 4, 5 AND 6: SET
LIMITS AND RELAYS67**

- 12.1: Trip Relay67
- 12.2: Time Delays & Relay Mode67
- 12.3: Group 4, Functions 0—3—
LM1/LM2 Set Limits.....68
- 12.4: Group 5, Functions 0—7—
LM1/LM2 Set Limits.....69
- 12.5: Group 6, Functions 0—5—
LM1/LM2 Set Limits and
Relay Triggers for Over/Under
%THD Conditions72
- 12.6: Limits or Relays Programming
Procedure72

**CHAPTER 13: PHASE REVERSAL
AND PHASE IMBALANCE
SET LIMITS/RELAYS...75**

- 13.1: Phase Reversal and Phase
Imbalance.....75
- 13.2: Trip Relay75
- 13.3: Group 7, Function 0—Voltage
Phase Reversal Detection.....76
- 13.4: Group 7, Function 1—
Percentage Voltage Phase
Imbalance.....77

**CHAPTER 14: EXITING THE PROGRAMMING
MODE79**

**CHAPTER 15: PROGRAMMING QUICK
REFERENCE...81**

- 15.1: Entering the Programming
Mode81
- 15.2: Data Entry Sequence.....81
- 15.3: Programming Groups81
- 15.4: Group 0: Global Setup82
- 15.5: Group 1: Full Scale Setup83
- 15.6: Group 2 Calibration.....83
- 15.7: Group 3 Calibration Ratios.....83
- 15.8: Group 4: Volt/Current Limits83
- 15.9: Group 5: Power Function Limits
.....84
- 15.10: Group 6: THD Limits84
- 15.11: Group 7 Imbalance/Reversal
Limits84
- 15.12: Group 8: DC Output
Calibration.....84

CHAPTER 16: ETHERNET OPTION87

- 16.1: Ethernet Module
DMMS350.....87
- 16.2: Ethernet Option Setup88
- 16.3: Default IP Address.....89
- 16.4: AutoIP.....89
- 16.5: Setting the IP Address.....89
- 16.6: Network Configuration..... 90
- 16.7: Configuration Parameters.....91

CHAPTER 1

AC POWER MEASUREMENT

The economics of electric power distribution networking dictate several configurations of AC power transmission. The number of phases and voltage levels characterize these configurations.

1.1: Single Phase System

A **single phase system** is a basic two-wire system used in low power distribution applications, such as residential communities or offices. Typically, the voltage is 120V AC. For higher power requirements, such as small commercial facilities, the typical power configuration is two lines of 120V AC opposite in phase (see **Figure 1.1 B**, below).

This system produces 120 volts from line to neutral for lighting and small appliance use. The line-to-line voltage is 240V AC, used for higher loads such as water heaters, electric dryers, ranges and machinery.

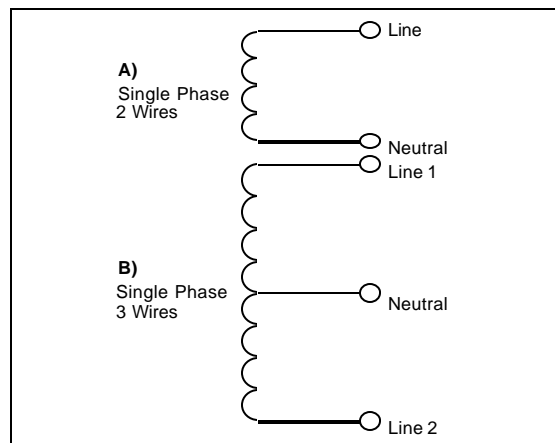

Figure 1.1: Single Phase System: (A) Two-Wire, (B) Three-Wire

The power (**W**) in a single phase system is: $W = E \cdot I \cdot \cos\Theta$

E = potential, **I** = current, and **cosQ** = phase difference between the potential and the current.

Power in a 120/240V AC system is: $W = (E_{Line1} \cdot I_{Line1} \cdot \cos\Theta) + (E_{Line2} \cdot I_{Line2} \cdot \cos\Theta)$

Phase differential between the potential and the current results from a non-resistive load, either reactive or capacitive.

Reactive power (VAR): The additional power consumed that does not produce any work but must be delivered to the load: $VAR = E \cdot I \cdot \sin\Theta$. This is a measure of the inefficiency of the electrical system.

Apparent power (VA): The total power delivered to the load, and the vector sum of real power and reactive power.

Power Factor (PF): The ratio between real power and apparent power: $PF = \frac{W}{VA} = \frac{W}{\sqrt{W^2 + VAR^2}}$

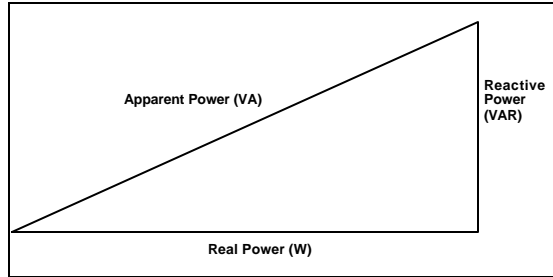

Figure 1.2: Relationship between apparent, real and reactive power

Ideal power distribution should have a PF of 1. This condition can be met only if no reactive power loads exist. In real life applications, many loads are inductive loads. Often, corrective capacitors are installed to correct Poor Power Factor (see Section 1.3).

1.2: Three-Phase System

A **three-phase system** delivers higher levels of power for industrial and commercial applications; the three phases correspond to three potential lines. A 120° phase shift exists between the three potential lines.

A typical configuration has either a Delta connection or a Wye connection (see **Figure 1.3**, below).

In a three-phase system, the voltage levels between the phases and the neutral are uniform and defined by:

$$E_{an} = E_{bn} = E_{cn} = \frac{E_{ab}}{\sqrt{3}} = \frac{E_{bc}}{\sqrt{3}} = \frac{E_{ac}}{\sqrt{3}}$$

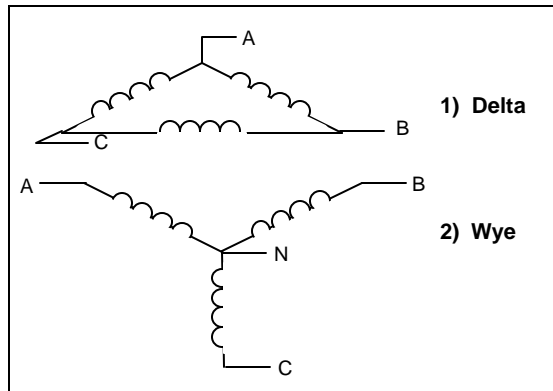

Figure 1.3: Three-Phase System: (1) Delta, (2) Wye

Voltages between the phases vary depending on loading factors and the quality of distribution transformers. The three-phase system is distributed in different voltage levels: 208V AC, 480V AC, 2400V AC, 4160V AC, 6900V AC, 13800V AC, and so on.

Power measurement in a poly phase system is governed by **Blondel's Theorem**. Blondel's Theorem states that in a power distribution network which has N conductors, the number of measurement elements required to determine power is N-1. A typical configuration of poly phase system has either a Delta connection or a Wye connection (see **Figure 1.4**, below).

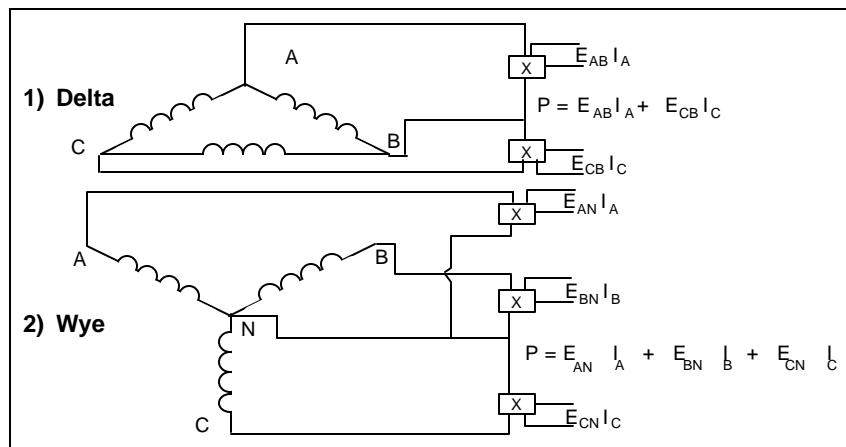

Figure 1.4: Poly Phase System: (1) Delta, (2) Wye

1.3: Consumption, Demand and Poor Power Factor

CONSUMPTION: $WH = W \times T$ **W** = instantaneous power **T** = time in hours

The total electric energy usage over a time period is the consumption of WH.

Typically, the unit in which consumption is specified is the kilowatt-hour (KWH): one thousand watts consumed over one hour. Utilities use the **WH** equation to determine the overall consumption in a billing period.

DEMAND: Average energy consumed over a specified time interval. The utility determines the interval, typically 15 or 30 minutes. The utility measures the maximum demand over a billing period. This measurement exhibits a deviation from average consumption, causing the utility to provide generating capacity to satisfy a high maximum consumption demand. The highest average demand is retained in the metering system until the demand level is reset.

POOR POWER FACTOR: Results in reactive power consumption. Transferring reactive power over a distribution network causes energy loss. To force consumers to correct their Power Factor, utilities monitor reactive power consumption and penalize the user for Poor Power Factor.

1.4: Waveform and Harmonics

Ideal power distribution has sinusoidal waveforms on voltages and currents. In real-life applications, where inverters, computers, and motor controls are used, distorted waveforms are generated. These distortions consist of harmonics of the fundamental frequency.

SINUSOIDAL WAVEFORM: $A \cdot \sin(\omega \cdot t)$

DISTORTED WAVEFORM: $A \cdot \sin(\omega \cdot t) + A_1 \cdot \sin(\omega_1 \cdot t) + A_2 \cdot \sin(\omega_2 \cdot t) + A_3 \cdot \sin(\omega_3 \cdot t) + \dots$

TOTAL HARMONIC DISTORTION (THD):

$$\% \text{ of THD} = \frac{\text{RMS of Total Harmonic Distortion Signal}}{\text{RMS of the Fundamenta l Signal}} \times 100$$

HARMONIC DISTORTION: A destructive force in power distribution systems. It creates safety problems, shortens the life span of distribution transformers, and interferes with the operation of electronic devices. The Futura+ monitors the harmonic distortion to the 31st harmonic. A waveform capture of distorted waveform is also available.

% THD GRAPH

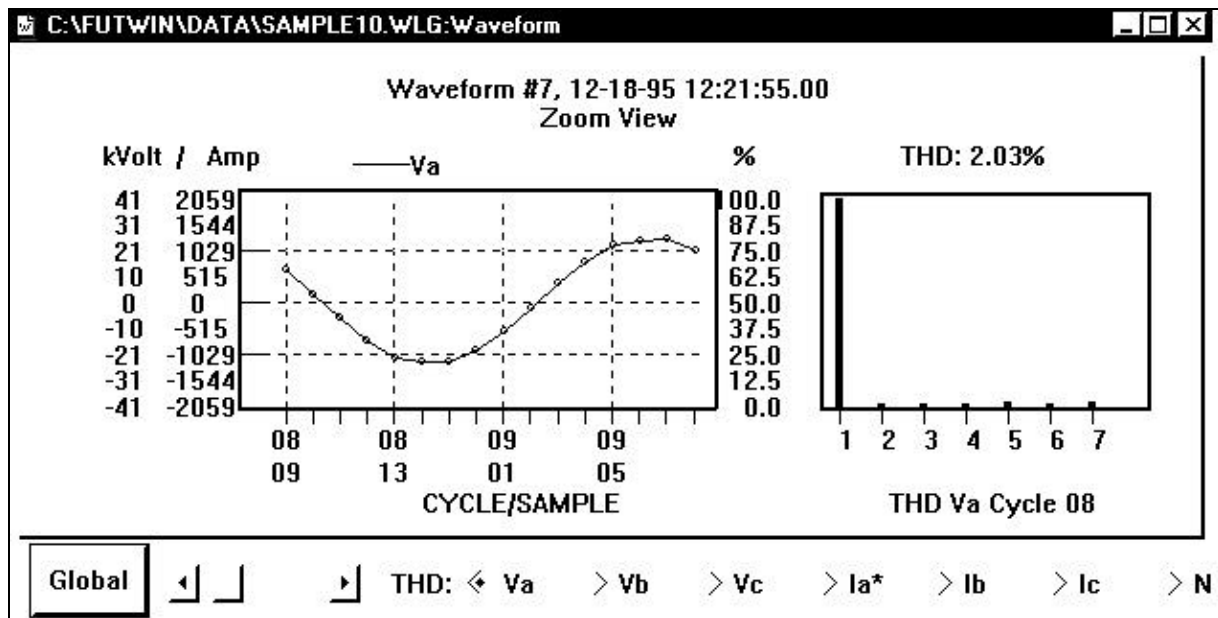

CHAPTER 2

MECHANICAL INSTALLATION

These diagrams display the various possible mechanical installations and Communication Converter installation. The various models use the same hookup and installation.

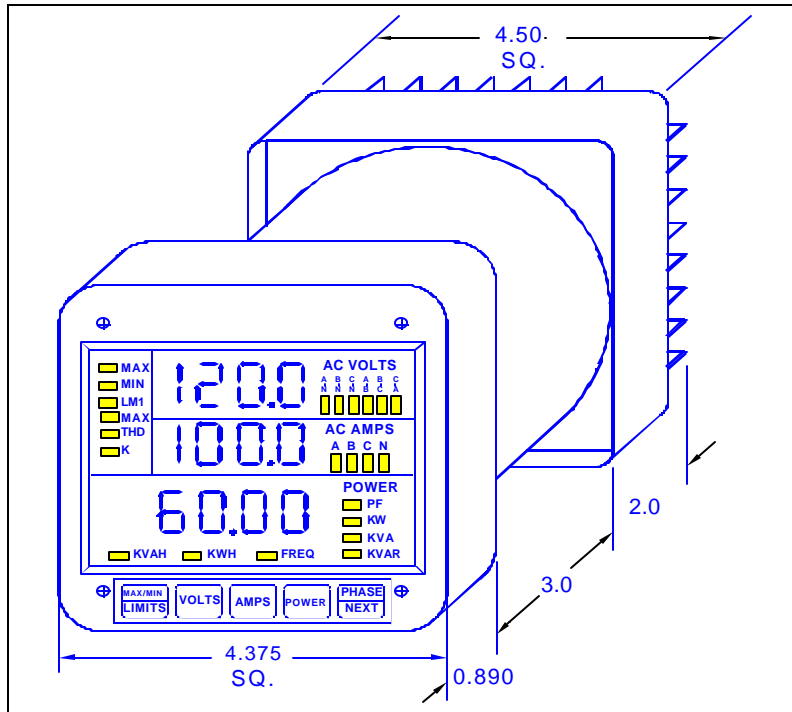

Diagram 2.1: Standard installation

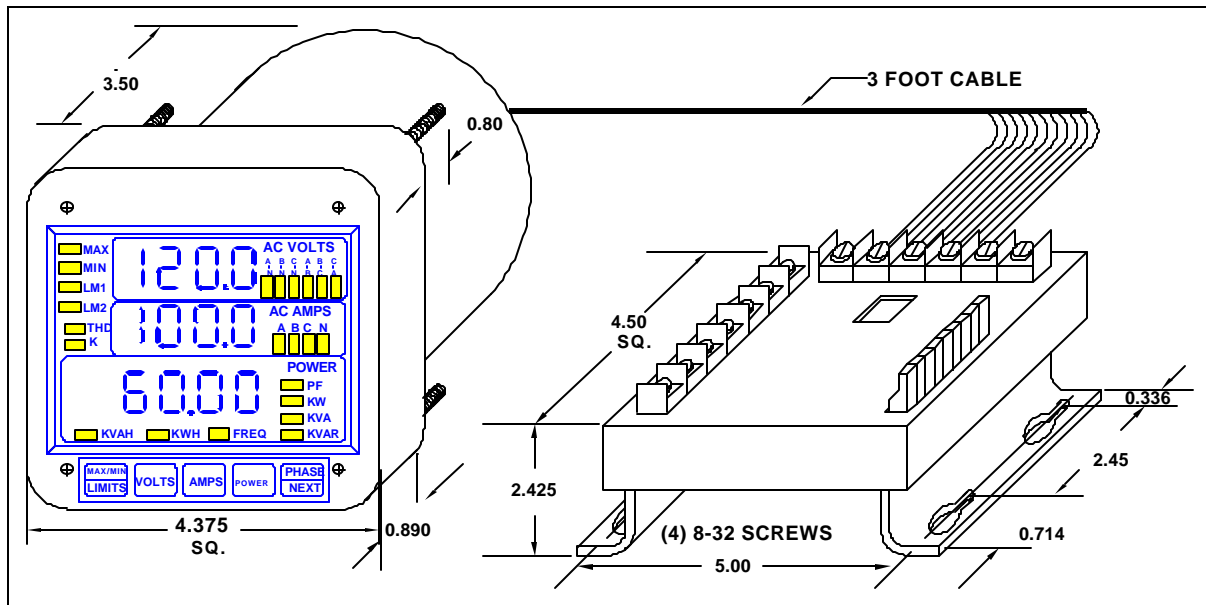

Diagram 2.2: Installation with K-110 option for limited space conditions

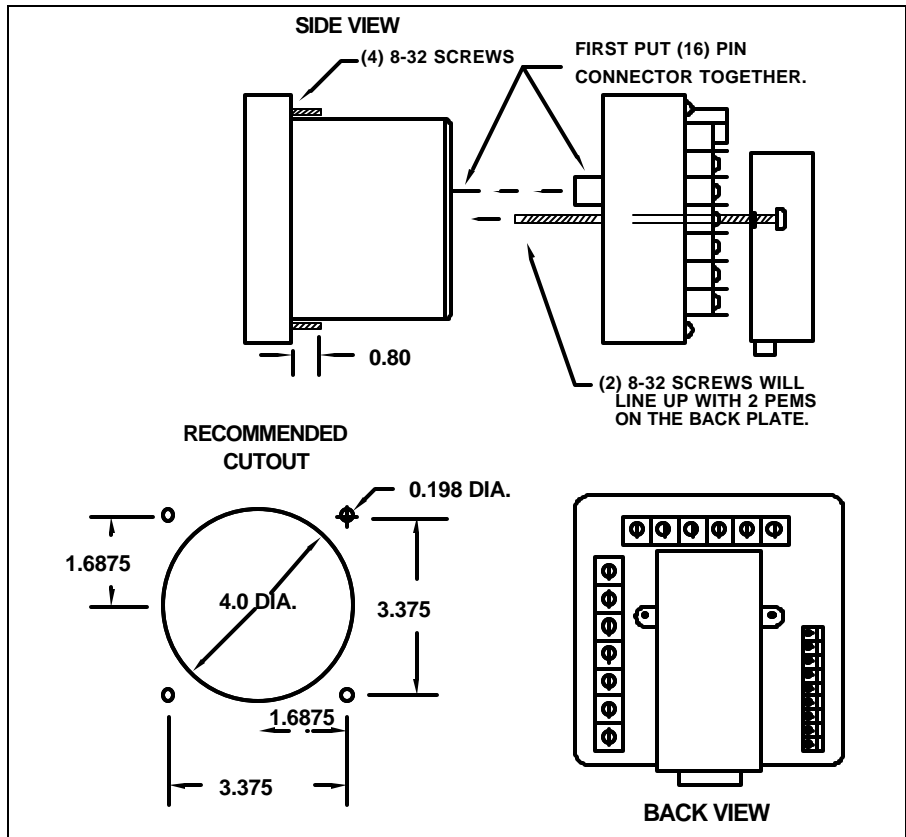

Diagram 2.3: Standard cutout

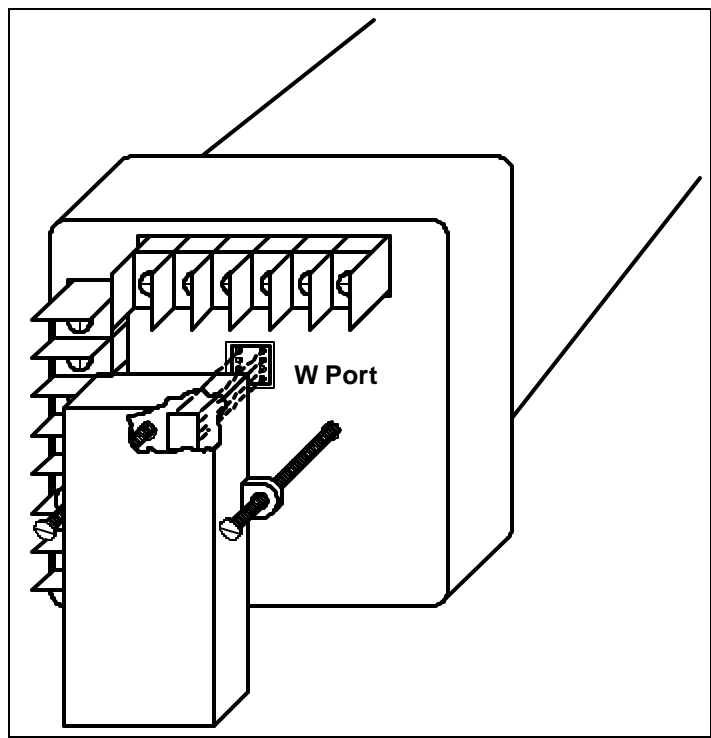

Diagram 2.4: Optional Communication Converter or DC Output Module Installation

* Recommended wire gauge is 20 AWG for DC Output or RS-485 options.

Note: Carefully line up the guide screw and 8 pin port connector to prevent pin breakage.

CHAPTER 3

ELECTRICAL INSTALLATION

3.1: Connecting the Current Circuit

Install the wiring for the current at 600V AC insulation as a minimum. The cable connector should be rated for 6 Amps or greater and have a cross-sectional area of 16 AWG minimum.

Mount the current transformers (CTs) as close as possible to the meter for best accuracy. The following table illustrates the maximum recommended distances for various CT sizes, assuming the connection is via 16 AWG cable.

CT Size	Maximum Distance (CT to Meter)
2.5 VA	10 FEET
5.0 VA	15 FEET
7.5 VA	30 FEET
10.0 VA	40 FEET
15.0 VA	60 FEET
30.0 VA	120 FEET

Table 3.1: CT Size and Maximum Distance

WARNING:

DO NOT leave secondary of the CT open when primary current is flowing. This causes high voltage that will overheat the secondary of the CT. Use a shorting block on the secondary of the CT.

3.2: CT Connection

If the meter is connected directly to the current (up to 10 Amps max.), maintain the exact connection to avoid incorrect polarity.

When the meter is connected using the CTs, you must maintain the correct CT polarities. CT polarities are dependent upon correct connections of CT leads, and upon the direction the CTs are facing when clamped around conductors. The dot on the CT must face the line side; the corresponding secondary connection must connect to the appropriate input on the meter. Failure to connect CTs properly results in inaccurate power readings. If your meter is not reading power properly, it is more than likely the CT is incorrectly wired.

Note: *CTs are shorted if connected to the terminal block model DSP2 or 3, even if it is detached from the meter.*

HELPFUL DEBUGGING TOOLS

OPTION 1: ISOLATING A CT CONNECTION REVERSAL POWER READING

If your meter does not read the correct watts after installation, it almost always means that the CT's have been wired in the wrong polarity. To check the polarity of the CT after the monitor has been installed, look at the single phase WATT readings to see that each of the readings are positive (assuming you are consuming power). If one of the WATT readings is negative, that particular phase CT is reversed. To check the single phase WATT reading, press the Power button twice while the annunciator is positioned to WATTS. Then press the Phase/Next button to cycle through the phases. After connecting the polarity of the CTs, the WATT and VAR readings should be correct.

OPTION 2: ISOLATING A CT CONNECTION REVERSAL USING VOLTAGE READINGS

- ⇒ Remove potential connections to terminals 6 and 7. Observe the KW reading. It should be positive.
- ⇒ If negative, reverse the CT wires on terminals 8 and 9.

Connect terminal number 6 potential. If KW decreases to about zero, reverse CT wires on terminals 10 and 11.

Connect terminal number 7 potential. If KW is one-third of expected reading, reverse CT wires to terminals 12 and 13.

3.3: Connecting the Voltage Circuit

For proper meter operation, the voltage connection *must* be maintained. The voltage must correspond to the correct terminal.

The cable required to terminate the voltage sense circuit should have an insulation rating greater than 600V AC and a current rating greater than 0.1 A.

3.4: Selecting the Voltage Fuses

We strongly recommend using fuses on each of the sense voltages and the control power, although connection diagrams do not show them. Use a 1 Amp fuse on each voltage input.

The meter can handle a maximum voltage of 150V phase to neutral. PTs are required for higher voltages. Suffix -G extends the maximum direct voltage to 300V phase to neutral, 600 volt phase to phase.

3.5: Connection to the Main Power Supply

The meter requires separate control power to operate. Listed are the five different power supply options and corresponding suffixes.

CONTROL POWER	OPTION SUFFIX	CURRENT
120V AC	115 A	0.1 AAC
240V AC	230 A	0.05 AAC
12V DC	D4	0.10 ADC
24-48V DC	D	0.25-0.5 ADC
125V AC/DC (universal)	D2	0.10 AAC or DC

Table 3.2: Control Power and Current

Note: For DC-powered units, polarity should be observed. Connect the negative terminal to L and positive terminal to L1. An earth ground connection to chassis is mandatory for normal operation (terminal three). Do not ground the unit through the negative of the DC supply.

Note: Externally fuse power supply with a slow-blow 3 Amp fuse.

3.6: Electrical Connection Installation

Choose the diagram that best suits your application and maintain the CT polarity. Follow the outlined procedure to verify correct connection. **IMPORTANT:** For PT connections only, short terminals 3 and 4. Connect local ground to terminal 3. This protects the unit from spikes and transients.

- The meter and terminal module DSP3 are factory calibrated together; the serial numbers are matched on both. The DSP3 input module and the meter base **MUST MATCH!**
- Mismatching of the meter and DSP3 input module will cause inaccurate readings because calibration ratios are stored in the meter's memory, not in the DSP3 input module.

LIST OF CONNECTION DIAGRAMS

NOTE: See phase reversal if a message of CBA appears after installation.

- I Three-Phase, Three-Wire System Delta with Direct Voltage and CTs
- II Three-Phase, Three-Wire Open Delta with two CTs and two PTs
(Open Delta System should only be used if the electrical system is a 3-wire 2 PT OPEN DELTA Open Delta can be enabled or disabled in Programming GROUP 0, FUNCTION 3, Chapter 9, section 9.4)
- III Three-Phase, Three-Wire Open Delta with three CTs and two PTs
- IV Three-Phase, Four-Wire Wye with Direct Voltage and CTs
- V Three-Phase, Four-Wire Wye with CTs and PTs
- VI Single Phase with CT and PT Connection
- VII Dual-Phase System
- VIII Three Phase System

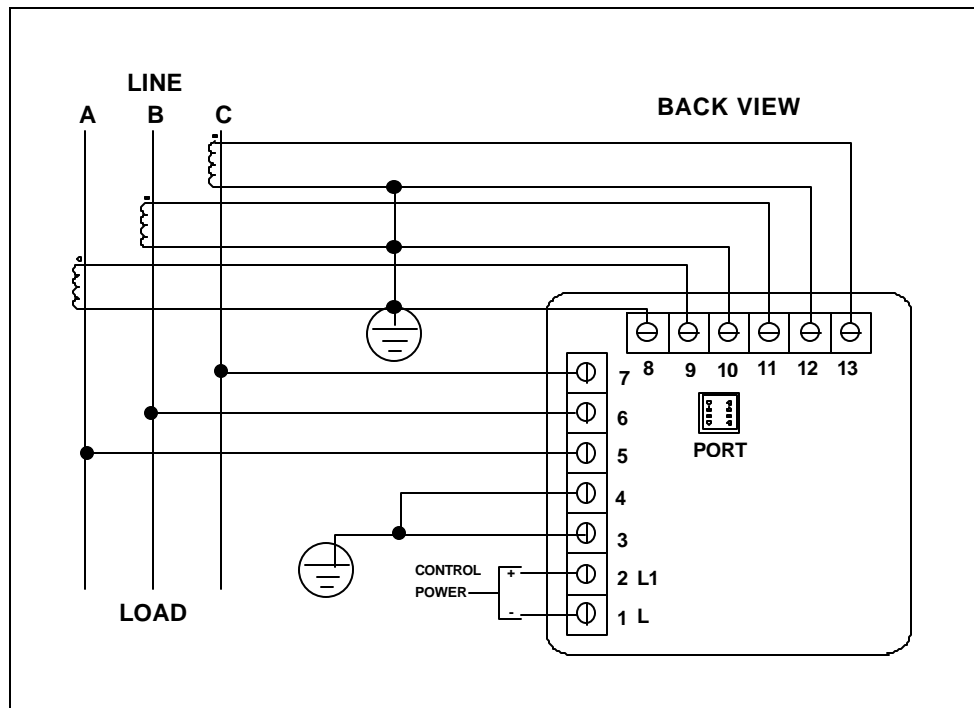

I. Three Phase, Three-Wire System Delta with Direct Voltage and CTs

Note: Remember to make sure Open Delta bit is programmed in the meters (See Chapter 9).

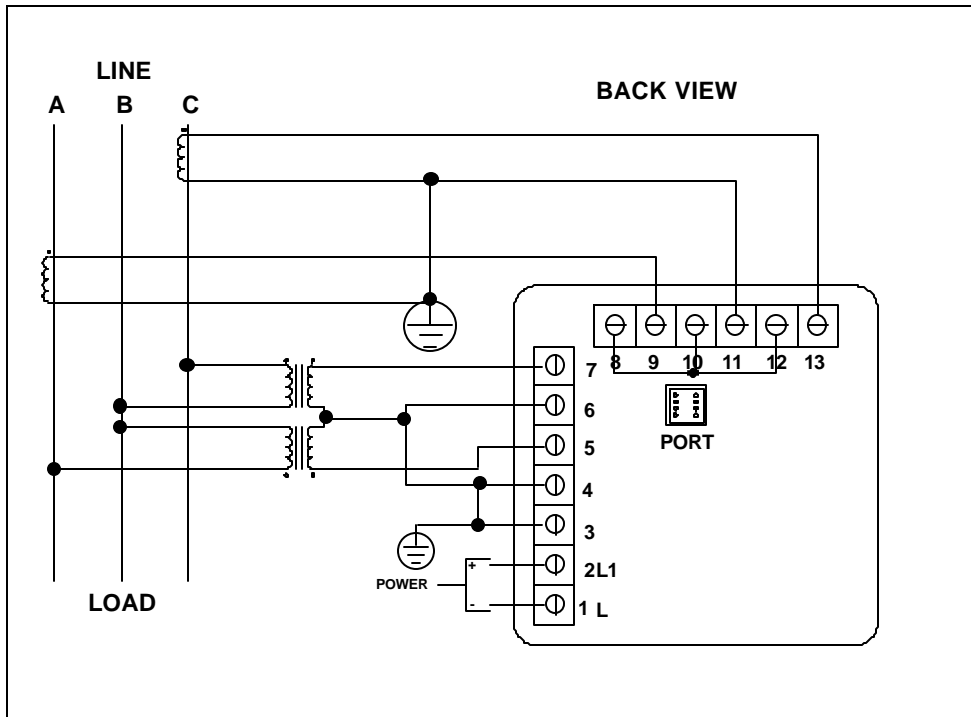

II. Three-Phase, Three-Wire Open Delta with two CTs and two PTs

Note: Remember to make sure Open Delta bit is programmed in the meter (see section 9.4).

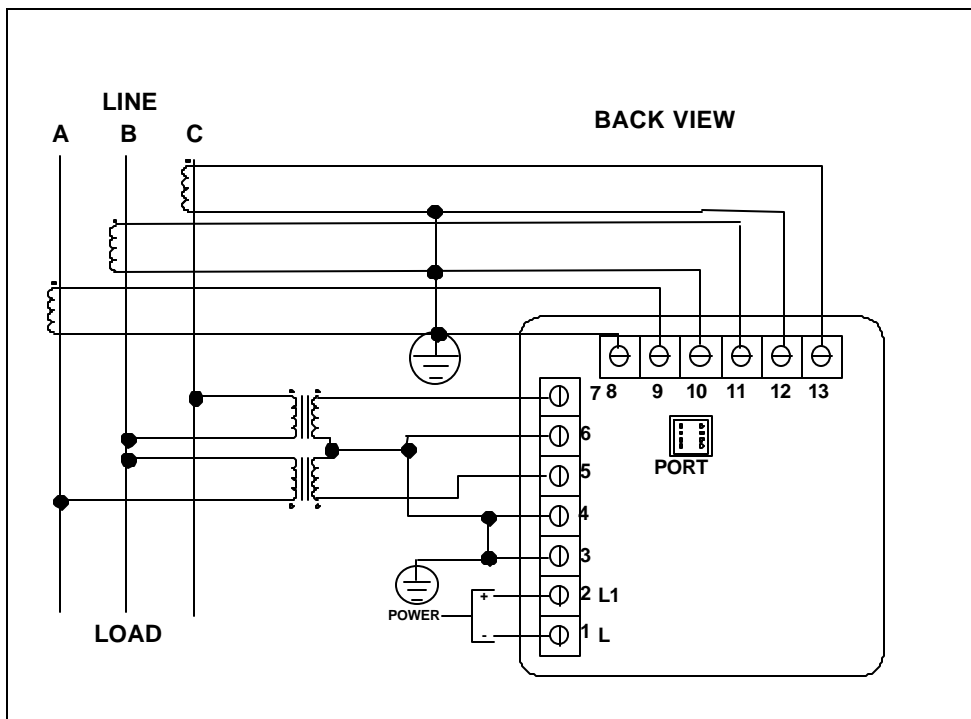

III. Three-Phase, Three-Wire Open Delta with three CTs and two PTs

Note: Remember to make sure Open Delta bit is programmed in the meter (see Chapter 9).

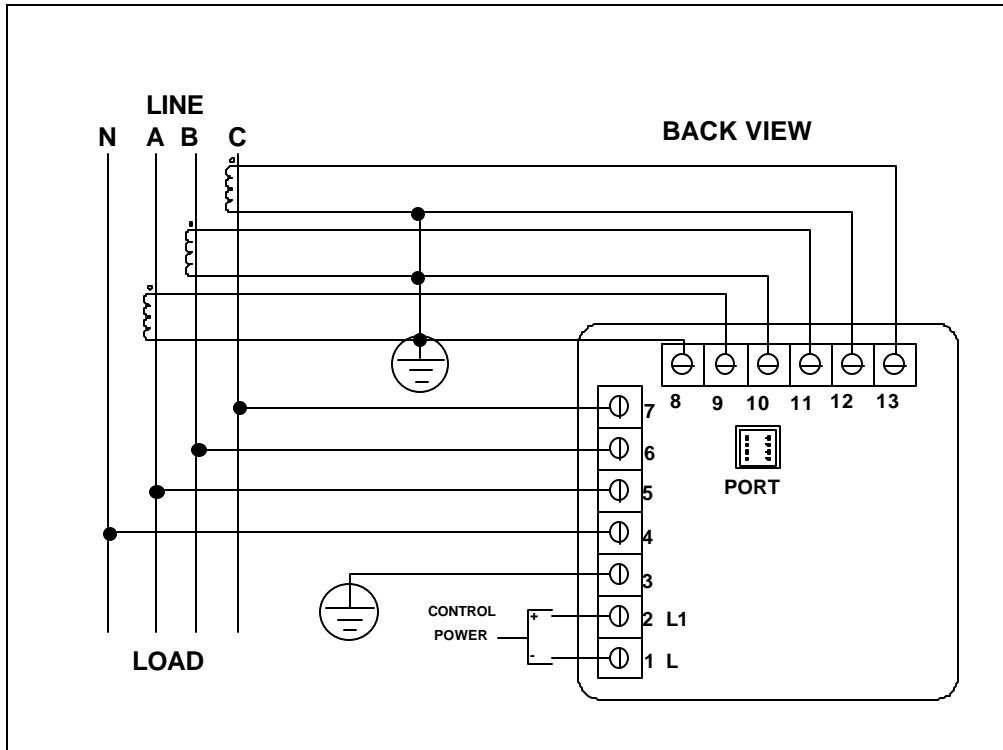

IV. Three-Phase Four-Wire Wye with Direct Voltage and CTs

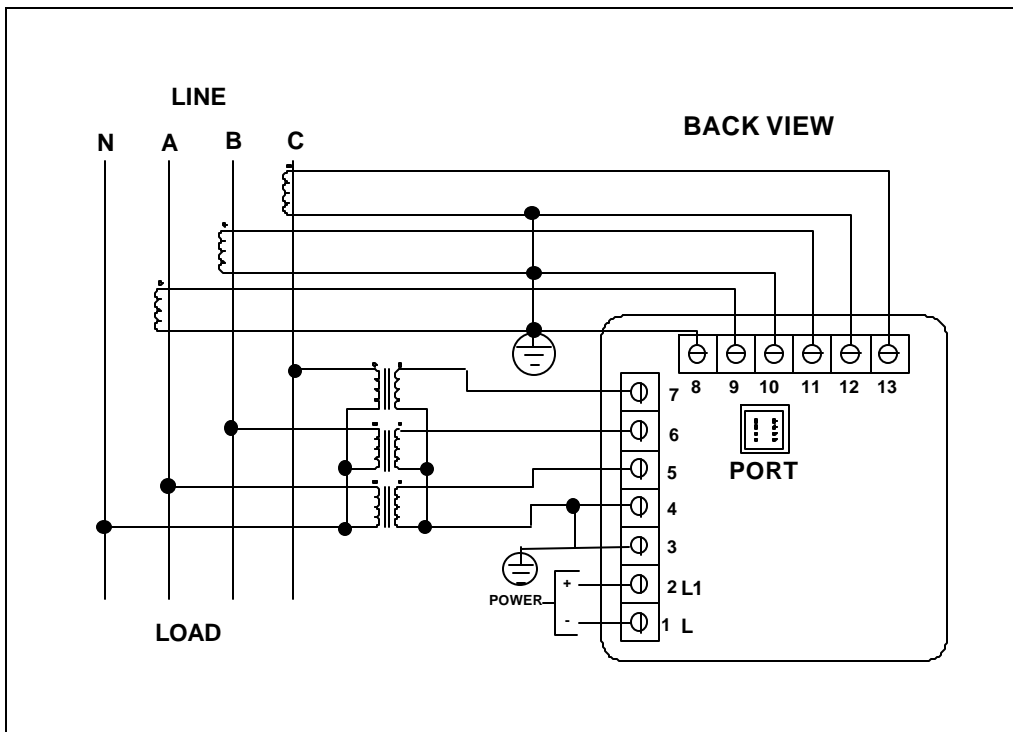

V. Three Phase Four-Wire Wye with CT and PTs

The DMMS-S

The DMMS-S is essentially the DMMS, where through the Programming Mode calculations are changed to reflect either **Single Phase** or **Dual Phase** readings.

Single Phase—The connection **MUST** be identical to Diagram VI.

Dual Phase—The connection **MUST** be identical to Diagram VII.

Program 1 for **Single Phase** or 2 for **Dual Phase** in GROUP 0, FUNCTION 7 to remove **Three-Phase** indicators from view.

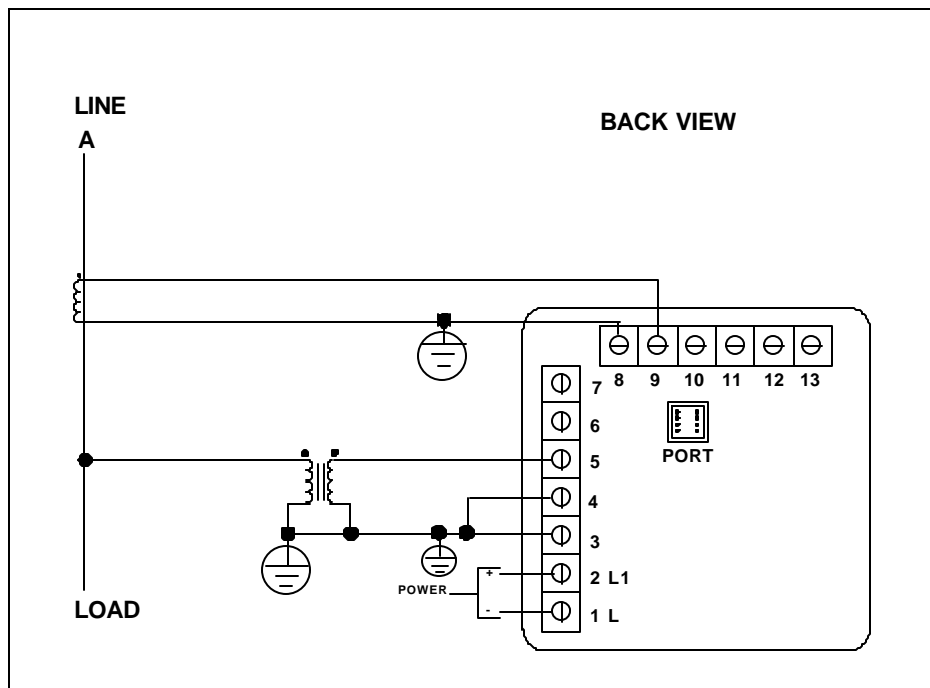

VI. Single Phase with CT and PT Connection

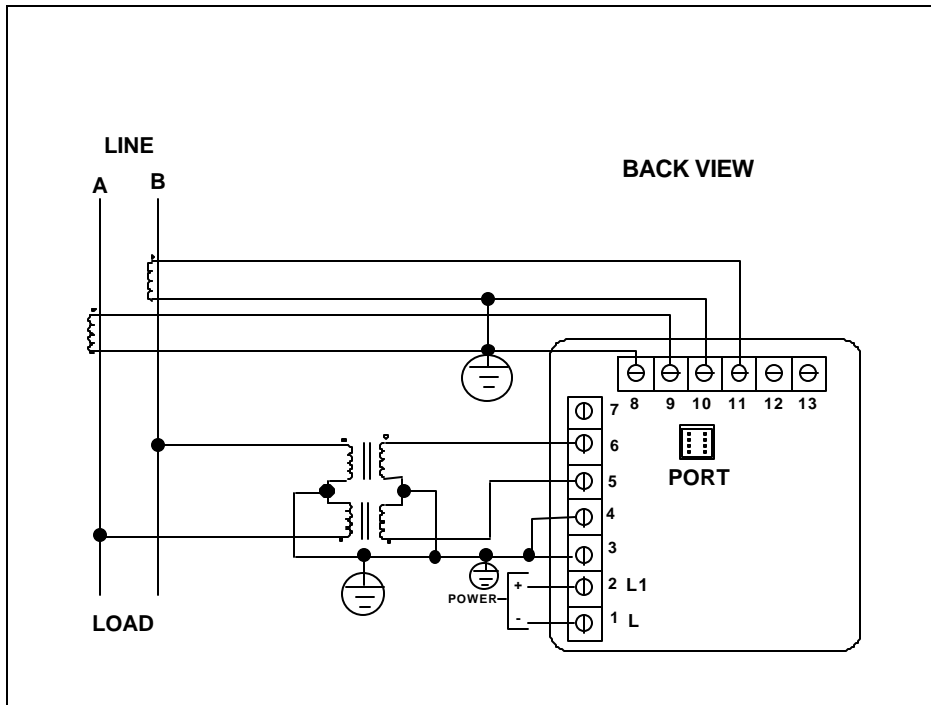

VII. Dual-Phase with CTs and PTs

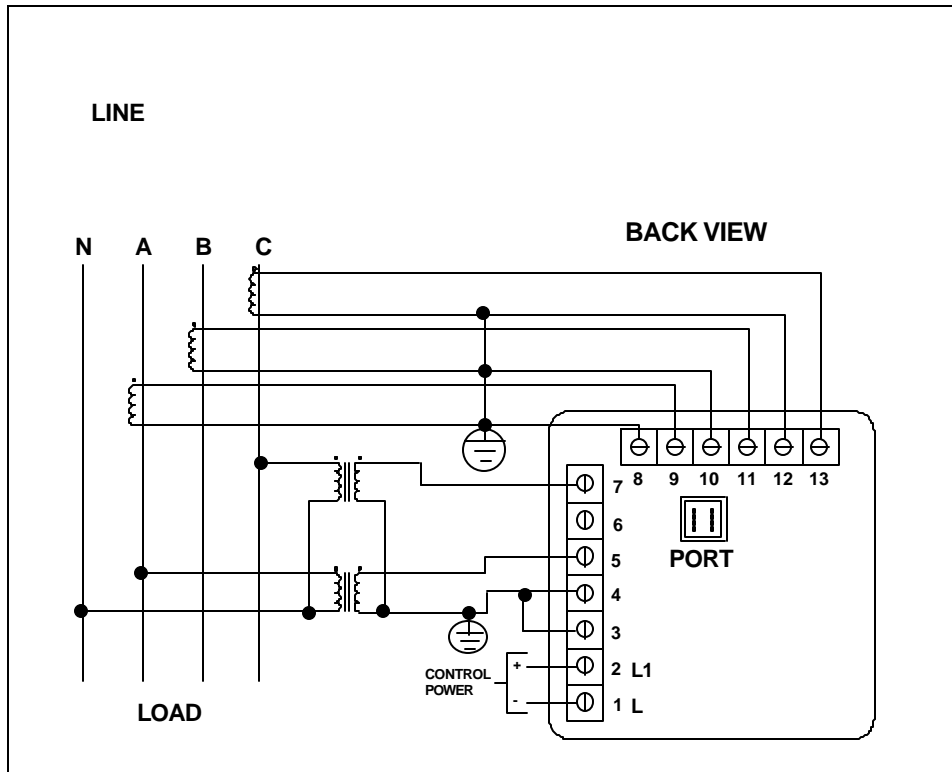

VIII. Three-Phase Four-Wire WYE with 2.5 Element

Note: The 2.5 element option must be custom configured from the factory. You must pre-order this configuration.

3.7: Relay, Protection and Pulse Output

(This section applies only to the -NL or -NL2 Relay Option.)

DMMS300+ RELAY OVERVIEW

The DMMS300+ offers dry contact relay output capability. The DMMS425 only offers KYZ pulse outputs and cannot be configured to trip contacts on events.

FAIL-SAFE MODE: The DMMS300+ -NL option gives the user an adjustable tripping bandwidth. The user specifies a range over which functions, such as frequency, phase relation and voltage, are acceptable. The relay releases during times of normal operation, and engages when functions are outside specified normal levels. The relay can be programmed to engage during normal operating conditions, and release outside specified normal range (particularly when power is lost). This is the **fail-safe mode**.

HYSTERISIS: The DMMS300+ -NL option also includes adjustable **hysterisis**. In addition to a time delay on activating any contact, the user may specify a lower level to release the relay, rather than releasing after the initial alarm point. This is ideal during load shedding when an alarm activates at a certain level and the user does not want to turn off the alarm until a much lower, safer level.

SETABLE DELAYS: After reaching the alarm point, a change in relay status may be delayed for 255 seconds. The user also has the option of allowing the device to change relay status without any delay. After the alarm condition passes, the relay can be stopped from returning to a normal condition for a programmable time. Each delay time is independent of one another.

AND/OR LOGIC: If several parameters are assigned to one relay, the user can trip the relay if all functions are out of limit (and programming), or if one function is out of limit (or programming). For example, if limits on Voltage, Kilowatts, and Phase Imbalance are programmed and tied to Relay 1, the user can either trip the relay if one function is out of limit, or if all functions are out of limit.

2 RELAYS & 1 KYZ PULSE OUTPUT -NL OPTION

The DMMS300+'s flexibility accesses a variety of relay options through the Programming Mode (see programming sections). The relay option package consists of three relays: two can be dedicated to alarm or controlled through communication (or both) and one for KYZ pulse output.

If the relays are controlled through communication, there are two different modes:

- Lock ON Relay will not be affected by any alarm condition.
- Lock OFF Relay will not be affected by any alarm condition.

If the relays are used for communication and alarm, there are four different modes:

- Lock ON Relay stays on regardless of any alarm condition.
- Lock OFF Relay stays off regardless of any alarm condition.
- Free ON Relay turns on unless other conditions force it off.
- Free OFF Relay turns off unless other conditions force it on.

Relay connection (see **Figure 3.1**, below): Form C relays, rated 250V, 5A–2 *each*.

KYZ relay output (Form C), rated 200V, 100mA–1 *each*.

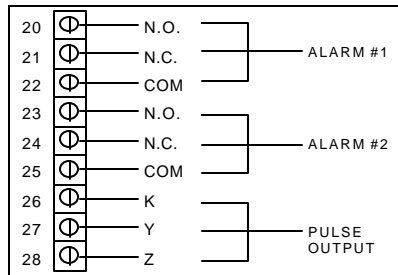

Figure 3.1: Close-up of the Relay and KYZ pulse output on the rear panel.

Note: The relays shown in the figure above are in the NOT energized state.

THE INSTRUMENT DETECTS TWO LEVELS OF ALARM FOR THE FOLLOWING FUNCTIONS:

- Voltage: AN, BN, CN, AB, BC, CA
- Current: A, B, C, N
- Over and Reverse Power
- Under PF/KVAR Lead or Lag
- Over KVA
- Voltage Imbalance (One level only)
- Over/Under Frequency
- Voltage Phase Reversals (One level only)
- Over/Under %THD (Available only with option -H)
- Over/Under K-Factor

KYZ RELAYS: Provides pulses for energy management systems or any other type of recording device. These pulses represent accumulated watt-hour, negative watt-hour, or VA-hour. Accomplish this assignment through the Programming Mode (see programming sections). The pulse value is determined by the decimal increment of the power function assigned to the pulse. The DMMS425 can be equipped with KYZ pulse outputs.

NOTE: Unless otherwise specified, standard KYZ setup represents positive watt hour. See table below for standard rate. The scale factor for wattage (KW or MW) and Full Scale Decimal Point Placement is selectable in Programming Mode GROUP 1, FUNCTION 2. Follow the Decimal Point Placement corresponding to the Change in Level. A multiplication or division factor can be programmed. See Programming GROUP 0, FUNCTION 6 for a different rate.

STANDARD RATE TABLE FOR WATTS*

DECIMAL POINT PLACEMENT (KW/MW)	CHANGE IN LEVEL
9999.000	1.0 Units W-Hour
999.900	0.1 Units W-Hour
99.990	0.01 Units W-Hour
9.999	0.001 Units W-Hour

**Units could be KiloWatts or MegaWatts.*

3.8: KYZ Pulse Outputs: NL2 Option

The -NL2 option for the meter is equipped with *three* KYZ outputs. KYZ relays provide pulses for energy management systems or any other type of recording device. These pulses represent accumulated positive watt-hour, negative watt-hour, VA-hour, positive VAR-hour, or negative VAR-hour. Accomplish this through Programming Mode GROUP 0, FUNCTION 6. The pulse value is dependent upon the Decimal Point Placement and is determined by the decimal increment of the power function assigned to the pulse. Refer to the situation that applies to the meter setting.

Note: Unless otherwise specified, standard KYZ setup for Pulse Output 0 is positive Watt Hour, Pulse Output 1 is negative Watt-Hour, and Pulse Output 2 is VA-hour. See table below for standard rate.

Note: With Option R (available only with the DMMS425) the setup for Pulse Output 0 is positive Watt-Hour, Pulse output 1 is positive VAR-hour, and Pulse output 2 is negative VAR-hour.

The scale factor for Wattage (KW or MW) and Full Scale Decimal Point Placement is selectable in Programming Mode GROUP 1, FUNCTION 2. Follow the Decimal Point Placement corresponding to the Change in Level. A multiplication or division factor can be programmed. See Programming GROUP 0, FUNCTION 6 for a different rate.

STANDARD RATE TABLE FOR WATTS*

DECIMAL POINT PLACEMENT (KW/MW)	CHANGE IN LEVEL
9999.0	1.0 Units W Hour
999.9	0.1 Units W Hour
99.99	0.01 Units W Hour
9.999	0.001 Units W Hour

*Units could be KiloWatts or MegaWatts.

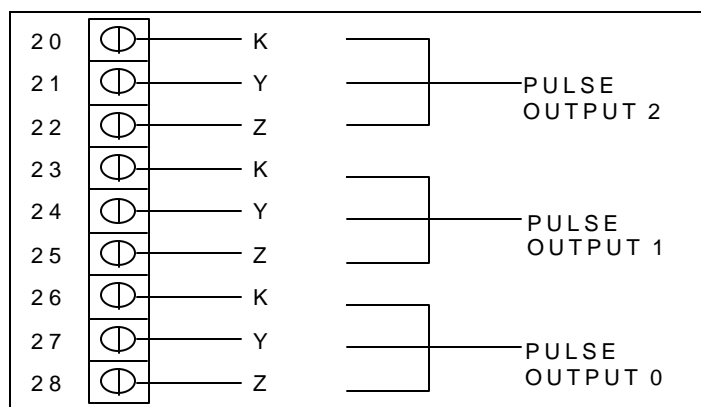

Figure 3.2: KYZ Relay Connection for -NL2 Option

KYZ relay output (Form C), rated 200V, 100mA: 3 separate KYZ Outputs (labeled 0 through 2).

CHAPTER 4

COMMUNICATION INSTALLATION

4.1: RS-232C

(This section applies to the RS-232C or RS-485.)

All DMMS instruments can be equipped with RS-232C or RS-485 communication.

RS-232C communication links a single instrument with a computer or device such as an RTU or PLC. Its capability is up to 100 feet. A standard 9-pin female serial port connector mounts on the instrument for direct connection to a computer with a 9-pin cable.

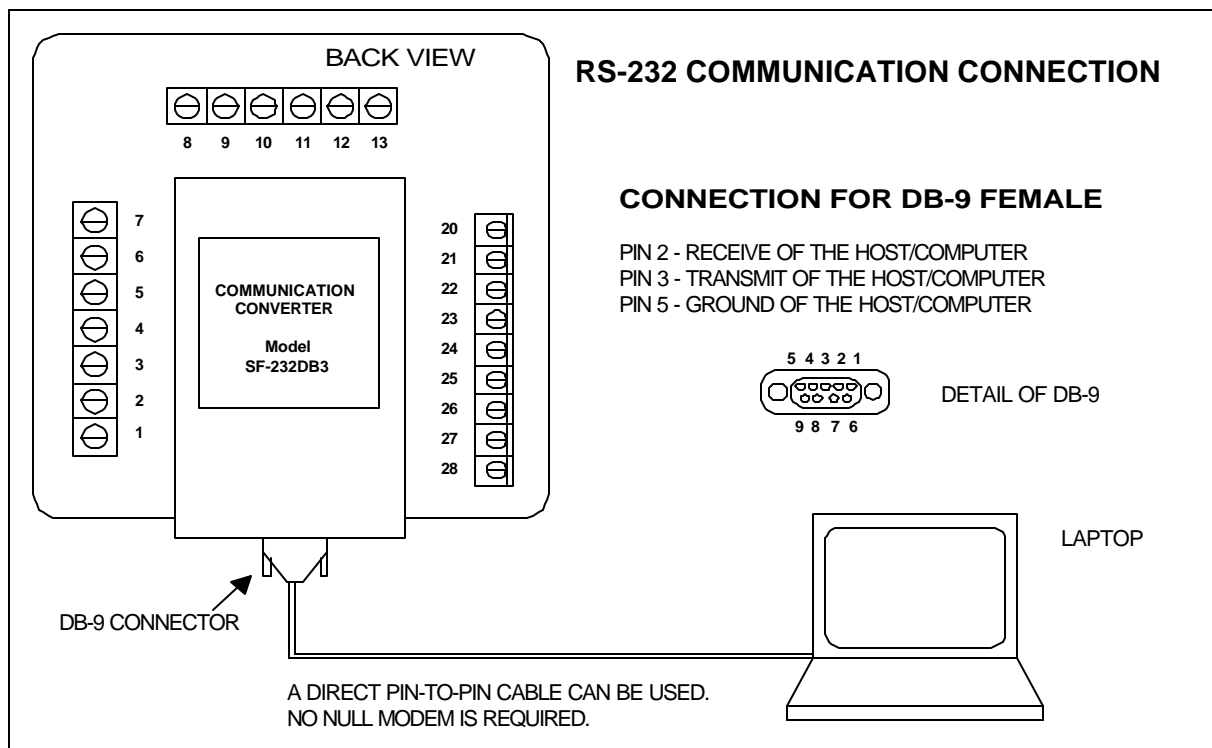

Figure 4.1: RS-232C Communication Connection Installation

Note: To avoid ground loops, the neutral and safety ground (pin 3) should be connected together at only one point.

4.2: RS-485

Each DMMS instrument has a unique address up to four digits long. Available standard baud rates are 1200, 2400, 4800, and 9600. To select the proper baud rate, apply the following rules:

The unit operates up to 9600 baud. For a smaller number of instruments over a long distance, use a lower baud rate. Optimal recommended baud rate is 1200 baud, if noisy conditions exist.

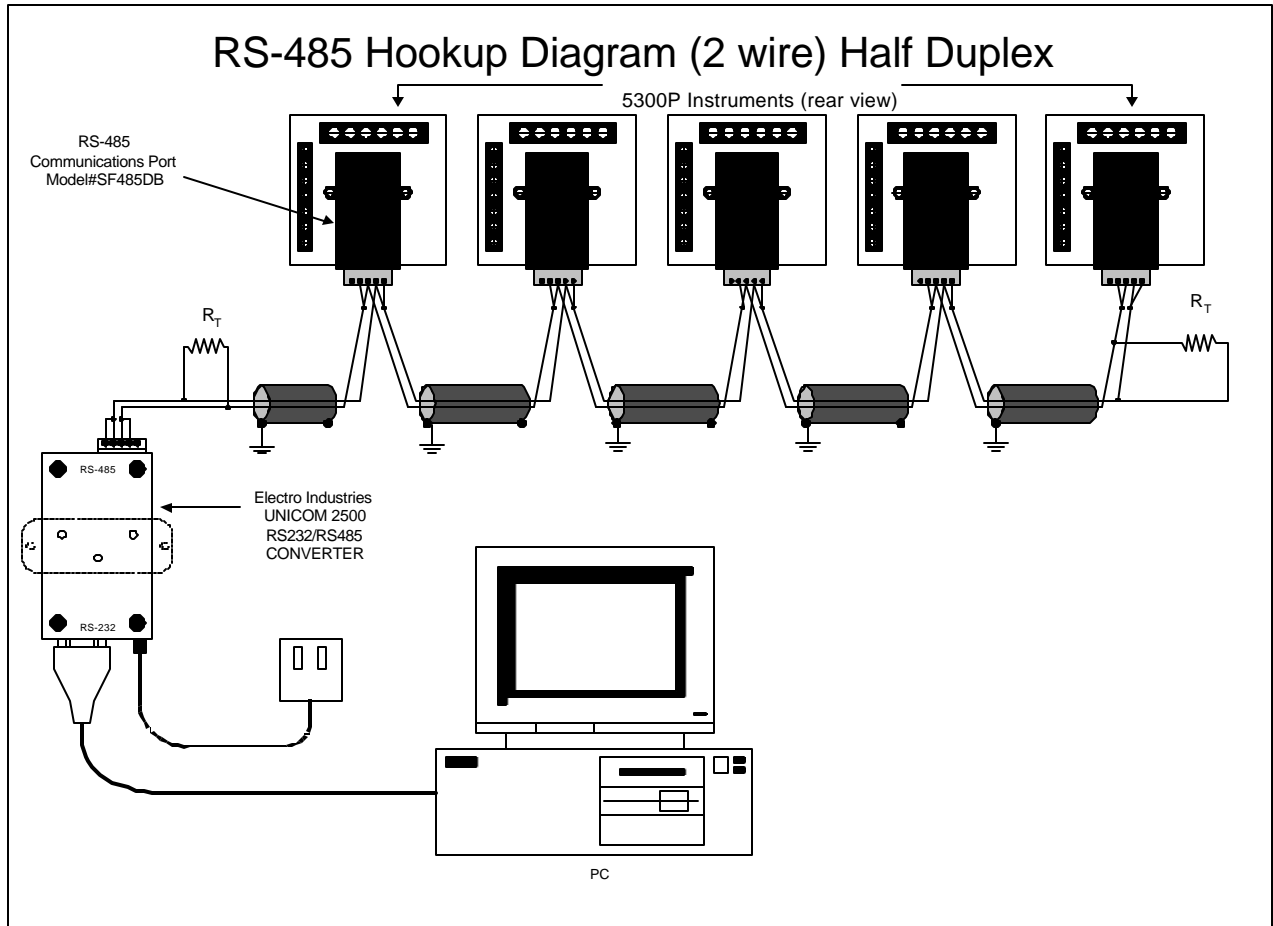

Figure 4.2: 2-Wire RS-485 Communication Connection Installation half duplex
 —Detail view on following page

RS-485 Hookup Diagram (2 wire) Half Duplex: Detail View

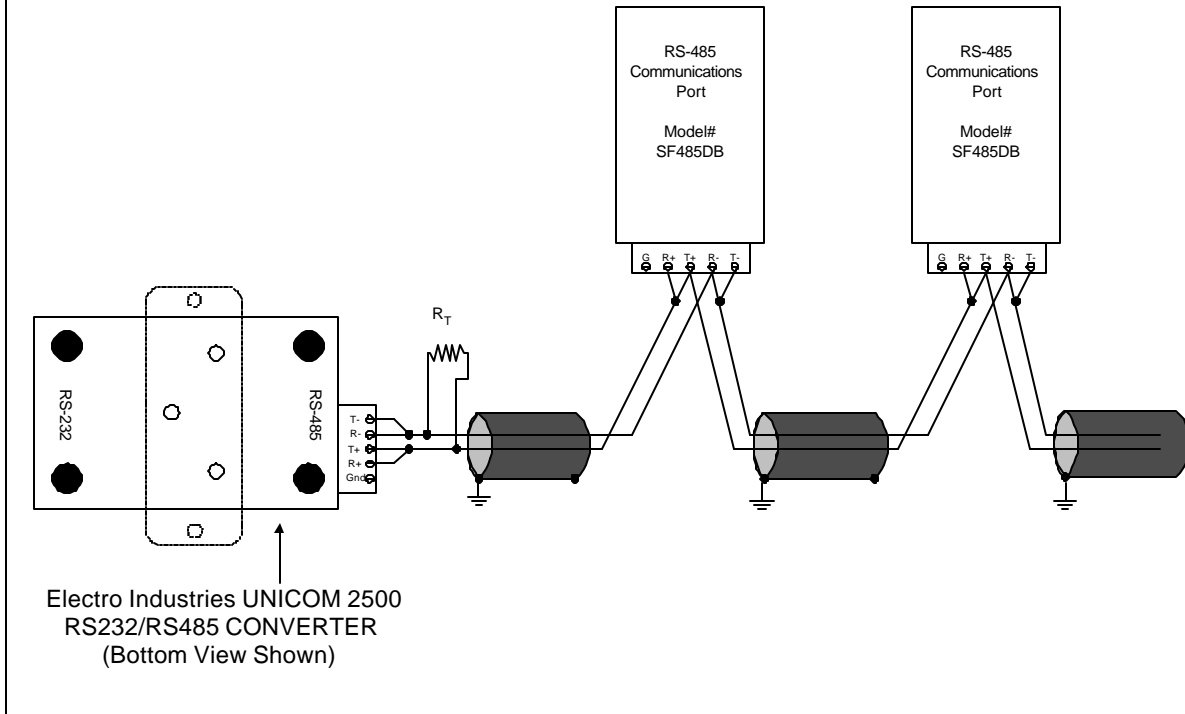

Figure 4.4: 2-Wire RS-485 Communication Connection Installation half duplex, detail view

4.3: Network of Instruments and Long Distance Communication

Use modems (dedicated or dial-up) when the instruments are located at great distances. However, set the modem to auto answer at the recommended value of 1200 baud rate, if noise conditions exist. Also, flow control must be disabled.

YOU MAY WANT TO USE A MODEM MANAGER RS485-RS232 CONVERTER

When speaking to most RS-485 or RS-232C based devices, the remote modem must be programmed for the communication to work. This task is often quite complicated because modems are quirky when talking to remote devices. To make this task easier, EIG has designed a **Modem Manager** RS-485 to RS-232C converter. This device automatically programs the modem to the proper configuration. Also, if you have poor telephone lines, modem manager acts as a line buffer, making the communication more reliable.

I. MODEM CONNECTED TO COMPUTER (ORIGINATE MODEM) Programming the Modem

Comply with the modem's instruction manual and follow these instructions:

RESTORE MODEM TO FACTORY SETTINGS:

- This procedure erases all previously programmed settings.

SET MODEM TO DISPLAY RESULT CODES:

- The device uses the result codes.

SET MODEM TO VERBAL RESULT CODE:

- The device uses the verbal codes.

SET MODEM TO IGNORE DTR SIGNAL:

- Necessary for the device to ensure connection with originate modem.

SET MODEM TO DISABLE FLOW CONTROL:

- Necessary to communicate with remote modem connected to device.

TELL MODEM TO WRITE THE NEW SETTINGS TO ACTIVATE PROFILE:

- Places these settings into nonvolatile memory; the settings take effect after the modem powers up.

II. MODEM CONNECTED TO THE DEVICE (REMOTE MODEM) Programming the Modem

Comply with the modem's instruction manual and follow these instructions:

RESTORE MODEM TO FACTORY SETTINGS:

- This procedure erases all previously programmed settings.

SET MODEM TO AUTO ANSWER ON **N** RINGS:

- Sets the remote modem to answer the call after **n** rings.

SET THE MODEM TO AUTO NEGOTIATE MODE:

- Sets the remote to auto negotiate to communicate successfully with DMMS300+ and other devices in the modem.

SET MODEM TO RETURN NUMERIC RESULT CODES:

- Increases speed connection with DMMS300+.

SET MODEM TO IGNORE DTR SIGNAL:

- Necessary for device to ensure connection with originate modem.

SET MODEM TO DISABLE FLOW CONTROL:

- Necessary to communicate with remote modem connected to DMMS300+.

TELL THE MODEM TO WRITE THE NEW SETTINGS TO ACTIVATE PROFILE:

- Places new settings into nonvolatile memory; settings take effect after the modem powers up.

Debugging Communication Problems

If you experience NO communication, check these conditions:

- Is the Baud Rate set correctly (see Part II: Programming Section)?
- Is the Meter Address set correctly (see Part II: Programming Section)?
- Is the correct protocol set? Modbus, DNP 3.0?
- Set the meter for the appropriate protocol for the Electro Industries software.

CHAPTER 5 OVERVIEW

The DMMS300+ displays 17 instantaneous electrical parameters. Values for each parameter are accessed through the keypad on the meter's front panel (see **Figure 5.1**). The DMMS425 accesses information in the same manner as the DMMS300+. The key strokes for each model are identical.

VOLTS	AMPS	POWER A, B, C
A-N	A	± KW
B-N	B	± KVAR
C-N	C	KVA
A-B	N	± PF
B-C		FREQ
C-A		± TOTAL KWH
		TOTAL KVAH (N/A ON DMMS425)

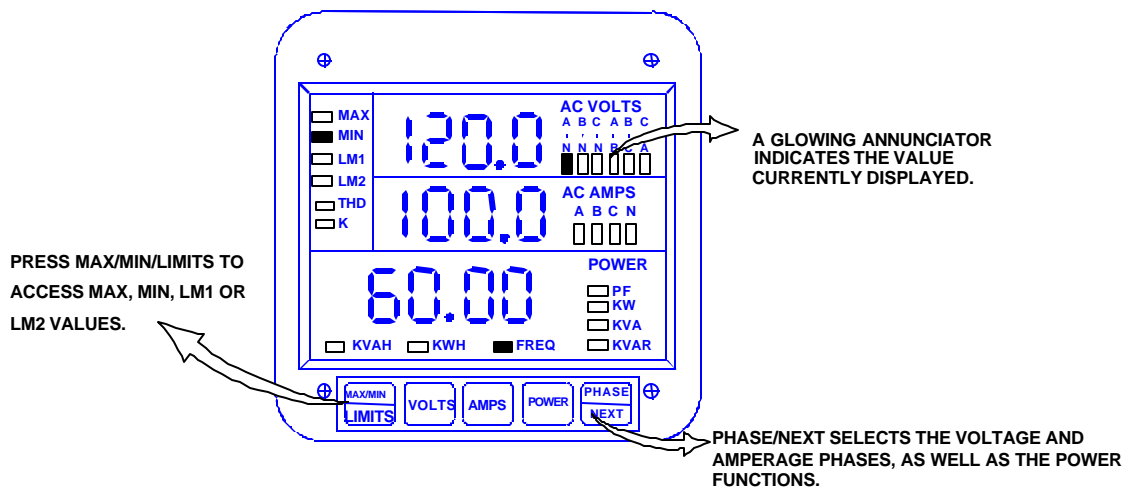
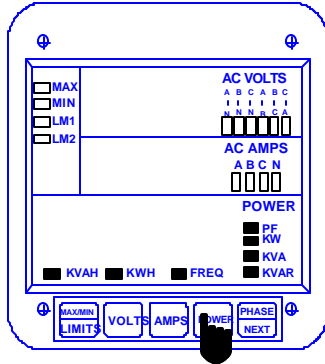

Figure 5.1: The DMMS300+ front panel with display and keypad.

5.1: Accessing the Power Functions



Step 1:

- a. Press **POWER** to select the power category.

⇒ The display blanks and all annunciators in the power section glow, confirming selection.

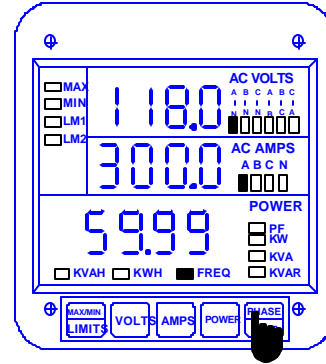

Step 2:

- a. Press **PHASE/NEXT** for the desired power function.

⇒ The functions are accessed in a clockwise sequence.

Note: For KWH readings: The first digit on the left of the KWH counter will blank out on the display when rollover at 199999 KWH occurs. The actual value of the first digit can only be viewed through digital communications. Or, reset the KWH counter to zero to avoid confusion.

5.2: Accessing Voltage and Current Phases

The DMMS300+ displays four current measurements (phases A, B, C, and Neutral) and six voltage measurements (phase-to-phase: A-B, B-C, C-A and phase-to-neutral: A-N, B-N, C-N).

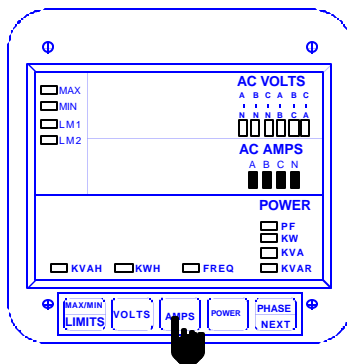

Step 1:

- a. To select the Amps (or Volts) category, press **AMPS** (or **VOLTS**).

⇒ The display blanks and all annunciators in the section glow, confirming selection.

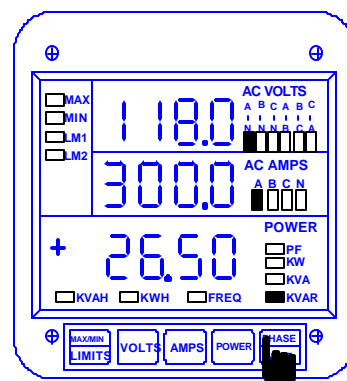

Step 2:

- a. Press **PHASE/NEXT** for the desired phase.

5.3: Accessing %THD Functions

Harmonic Measurement readings are available on the DMMS300+ -H meter. The DMMS300+ -H displays 6 parameters of total harmonic distortion. It measures harmonic waveforms and %THD for voltage phases A-N, B-N and C-N, and current phases A, B and C. Measurement capability reaches the 31st harmonic order. All readings are faceplate accessible.

To access %THD:

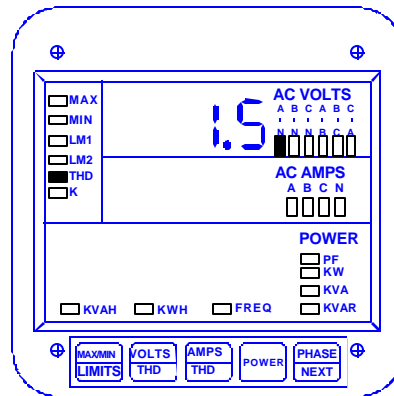
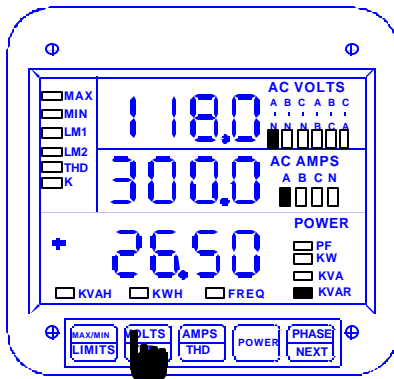

Step 1:

a. To access %THD values for a voltage or current phase press **VOLTS/THD** (or **AMPS/THD**) twice.

⇒ The display blanks and indicates the %THD value momentarily.

5.4: Viewing Individual Phase Indication for Power Functions

The DMMS300+ normally displays a three-phase indication for PF, KW, KVAR, KVA readings. To view the individual phase A, B and C for those power functions follow the procedure below. This procedure is particularly useful for detecting a current transformer (CT) polarity reversal. A CT polarity reversal will result in a low or negative KW indication, while the KVA will be unaffected.

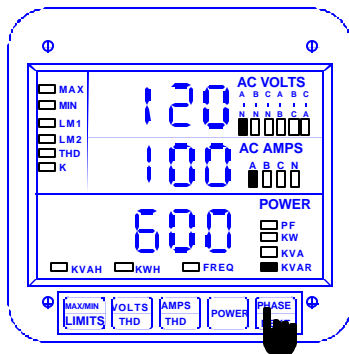

Step 1:

a. Press **POWER** to select power readings. Press **PHASE/NEXT** to select a specific power function (PF, KW, KVAR, KVA).

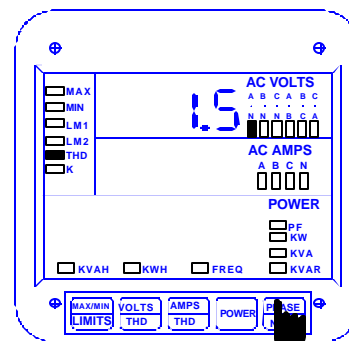

Step 2:

Press and hold the **POWER** button to scroll through the instantaneous single-phase power readings.

5.5: Accessing Max/Min Values

Max/min values represent the highest and lowest average demand over a user programmable time period known as the **Integration Interval**. The readings are calculated using a rolling average technique. Each second, a new reading is used to calculate the max/min; the last reading of the interval is dropped off. The highest max during an averaging period is stored until the user resets the max/min. This is similar to amp demand meters. It is commonly referred to as Thermal Demand.

To access a max/min value while displaying a desired measurement, press **MAX/MIN/LIMITS**—once for the max value; twice for the min. Examples given below are for voltage and current phases. Use the same procedure for all other parameters.

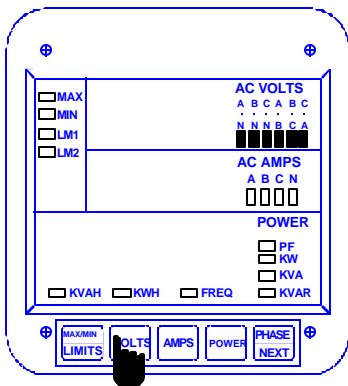

Step 1:
a. To select the Volts category, press **VOLTS**.

⇒ The display blanks and all annunciators glow, confirming selection.

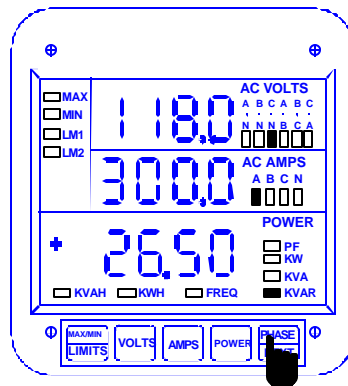

Step 2:
a. Press **PHASE/NEXT** for the desired phase.

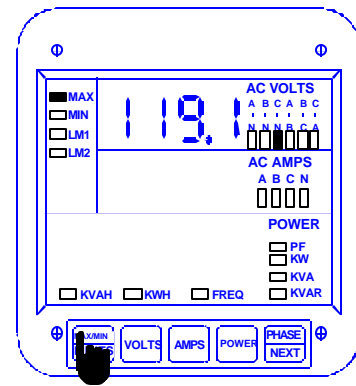

Step 3:
a. Press **MAX/MIN/LIMITS** once to view the maximum reading for Volts C-N.

⇒ The display blanks and momentarily indicates the max value.

To access KW, KVAR and PF negative measurements indicating leading current, press **MAX/MIN/LIMITS** five times for negative max and six times for negative min.

5.6: Resetting Values

Use the reset function if a new value is desired. It is available in two different modes.

1. **UNPROTECTED MODE:** Allows quick and easy resetting of max/min values.

2. **PROTECTED MODE:** Prevents unauthorized resetting the max/min and totaled power functions.

Note: *Even if the unprotected mode is selected during programming, the KWH and negative KWH are always in protected mode. The following examples are for the max/min.*

UNPROTECTED RESET

To reset the min of Amps A:

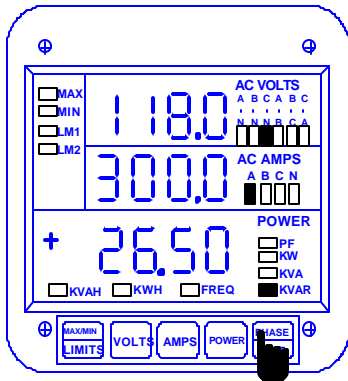

Step 1:

a. If not already in the Amps category press **AMPS**, then **PHASE/NEXT** until desired phase is indicated.

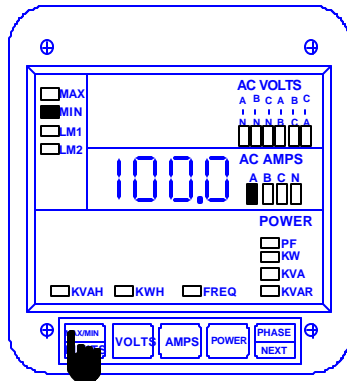

Step 2:

a. Press **MAX/MIN/LIMITS** twice to access the min value for Amps A.

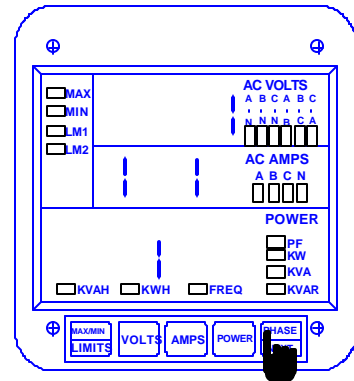

Step 3:

a. While the min value is displayed, press **PHASE/NEXT** to reset it.

⇒ The display blanks; a checkmark appears confirming reset.

⇒ Repeat this procedure for each value you wish to reset.

PROTECTED RESET

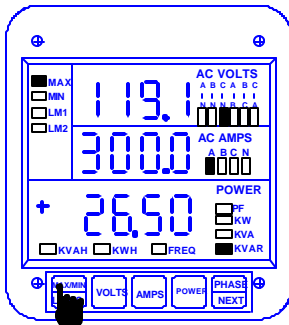

Step 1:

a. Press **MAX/MIN/LIMITS** once to access max value; twice to access min value.

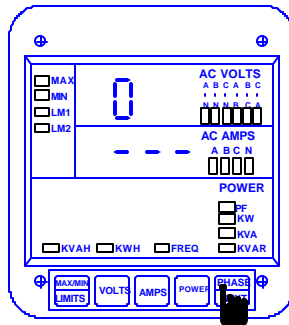

Step 2:

a. While the value is display, press **PHASE/NEXT** to commence protected reset.

⇒ The display blanks, three dashes appear in middle display and digits begin scrolling in upper display.

⇒ The password is **005**.

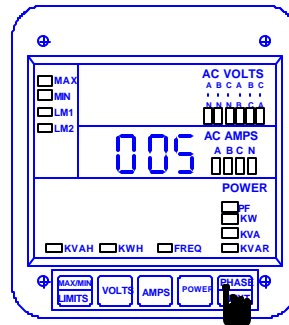

Step 3:

a. Press **PHASE/NEXT** each time a password digit appears.

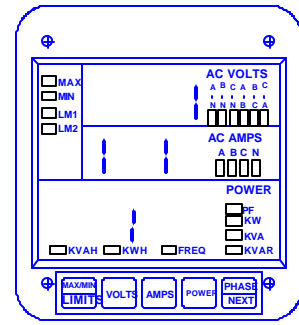

⇒ When the correct password is entered, a checkmark appears, confirming reset.

5.7: Resetting Hour Readings

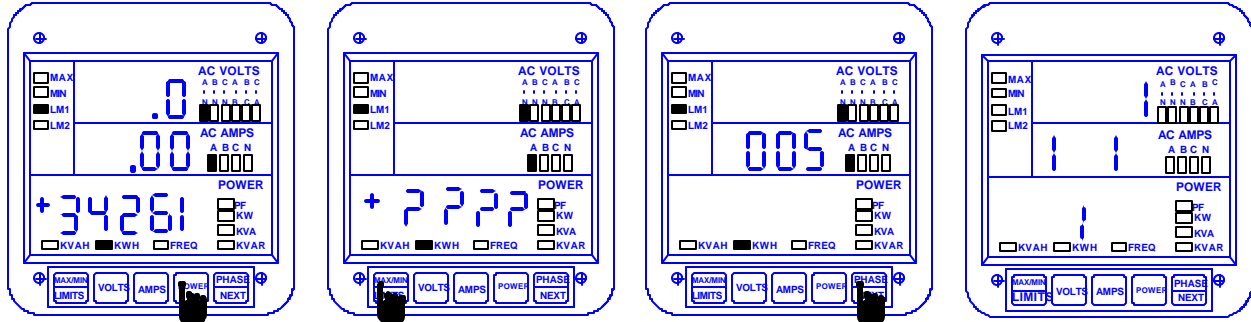

Step 1:

- Press **POWER** once.
- Press **PHASE/NEXT** for the desired hour function.

⇒ This example uses KWH function.

Step 2:

- Press **MAX/MIN/LIMITS**
 - once for positive hour reset
 - three times for negative hour reset.

⇒ Four question marks appear in lower display.

Step 3:

- While the question marks are displayed, press **PHASE/NEXT**. A password entry is now required.

⇒ The password is **005**.

- Press **PHASE/NEXT** each time a password digit appears.

⇒ Checkmarks appear, indicating a successful reset.

5.8: Accessing the LM1/LM2 Set Limits

The DMMS300+ has two manual set limits which monitor the instantaneous readings and warn the user of any abnormal conditions. Each limit detects readings either above or below a set level. The DMMS425 does not have this feature.

SET LIMITS: Point when the relay changes position, if the DMMS300+ is equipped with the Relay Option (Suffix -NL).

If a limit is exceeded, only the annunciator for LM1 and/or LM2 flash.

To view the setup of the LM1/LM2 set limits:

- Press **MAX/MIN/LIMITS** 2 times. to view the LM1 set limit momentarily.
- Press **MAX/MIN/LIMITS** 3 times to view the LM2 set limit momentarily.
- To locate readings that exceeded Limit 1, press **MAX/MIN/LIMIT** 3 times and then press **PHASE/NEXT**. The display blanks, the middle display indicates **L1**, and annunciators for parameters that exceeded Limit 1 illuminate.
- To locate readings that exceeded Limit 2, press **MAX/MIN/LIMIT** 4 times and then press **PHASE/NEXT**. The display blanks, the middle display indicates **L2**, and annunciators for parameters that exceeded Limit 2 illuminate.

5.10: Access Modes

The following access commands allow the user to perform specific operations.

ACCESS COMMANDS	OPERATION
1	Print Operating Data
2	Print Programming Data
3	Enter Programming Mode (see Programming Section)
4	Firmware Version/LED Test

Note: Print commands 1 and 2 are only available if enabled in the programming mode; they are not recommended when using the multimeter connection RS-485.

5.11 Print Operating Data

This function sends data to a serial printer, creating a hard copy of the instantaneous and max/min data of all functions and the WH, VAH, and WH counters.

Note: This function applies only if a serial printer is connected to the DMMS300+ via an RS-232C Communication Converter.

To print the operating data:

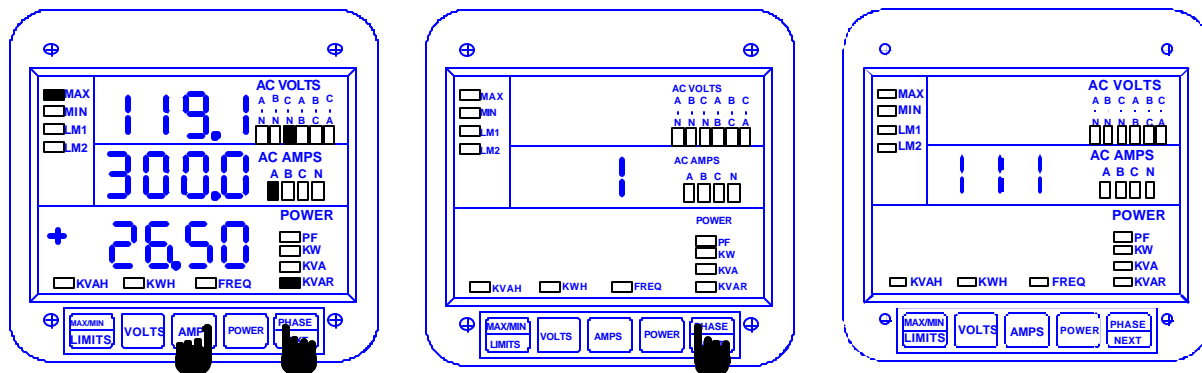

Step 1:

- Press and hold **PHASE/NEXT**.
- Press **AMPS** until a **0** appears in the middle display.
- Release both buttons.

Step 2:

- Press **AMPS** until a **1** appears..
- Press **PHASE/ NEXT** to select.

⇒ **111** appears, confirming a successful print command.

5.12: Print Programming Data

This function sends the programming data (or the meter setup) to a serial printer for verification and quick reference.

To print the programming data:

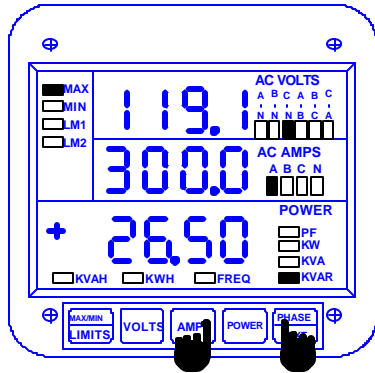

Step 1:

- Press and hold **PHASE/NEXT**.
- Press **AMPS** until a **0** appears in the middle display.
- Release both buttons.

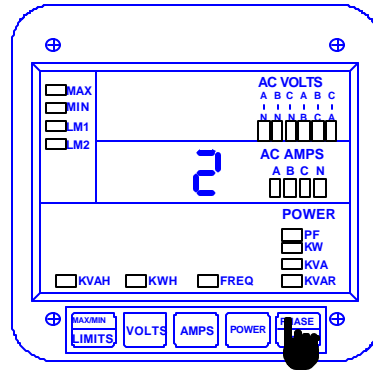

Step 2:

⇒ The display blanks.

- Press **AMPS** until a **2** appears.
- Press **PHASE/NEXT** to select.

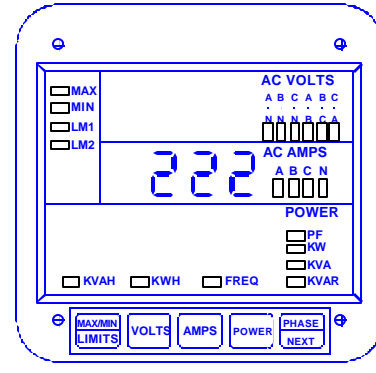

⇒ **222** appears, confirming a successful print command.

5.13: Accessing Firmware Version/LED Test

The DMMS300+ accesses the firmware version number of the analog and digital microprocessors. It also performs an LED test to check if the LEDs and annunciators are functioning properly.

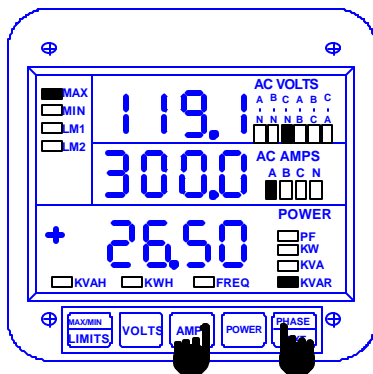

Step 1:

- Press and hold **PHASE/NEXT**.
- Press **AMPS** until a **0** appears in the middle display.
- Release both buttons

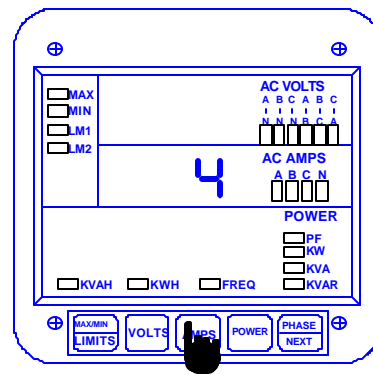

Step 2:

- Press **AMPS** until **4** appears.

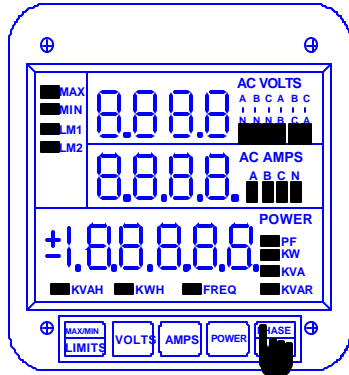

Step 3:
 a. Press **PHASE/NEXT** for the LED test.
 ⇒ All segments and annunciators glow.

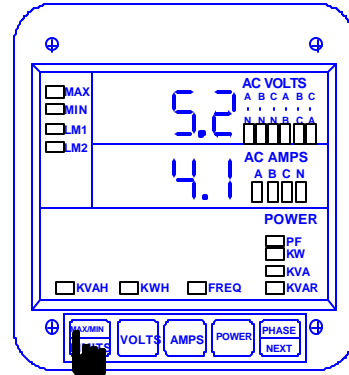

Step 4:
 a. Follow Steps 1 and 2, then press **MAX/MIN/LIMITS** for the firmware versions.

Firmware versions:

- Upper display— analog processor version
- Middle display— digital processor

CHAPTER 6

PROGRAMMING OVERVIEW

6:1: General Procedure

Programming tasks are arranged into nine major GROUPS. Within each GROUP are the specific meter FUNCTIONS. Outlined is the general approach to alter programming mode values.

1. Enter the Programming Mode.
2. Select the desired GROUP.
3. Once the desired GROUP is selected, select a FUNCTION within the GROUP. For GROUP 0, some functions are further divided into PACKS containing four switches referred to as switches A, B, C, D (left to right).
4. After the FUNCTION selection, proceed with DATA ENTRY of the new value for the desired parameter.
5. Proceed to program another location and/or exit the programming mode.

IMPORTANT: The full exiting procedure must be followed to store any new programming.

6.2: Switch Packs

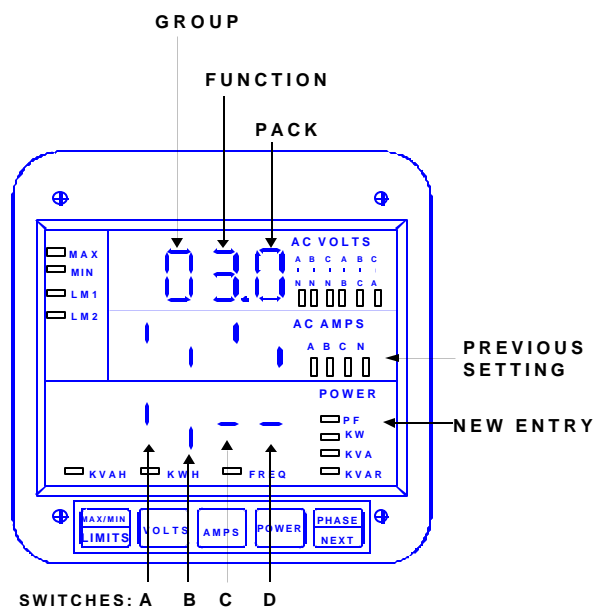

GROUPS, Functions, and Switch PACKS

- GROUPS are the main category.
- Functions are sub categories of GROUPS.
- Switch PACKS are sub categories of FUNCTIONS.

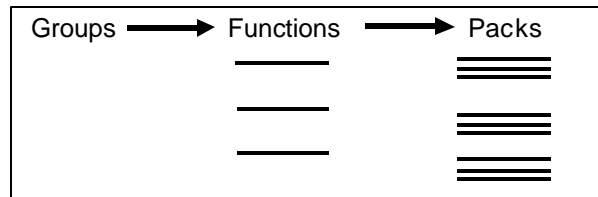

6.3: Programming Mode Data Entry

The DMMS300+ and DMMS425 programming mode utilizes only three out of the five-keypad buttons: the **MAX/MIN/LIMITS**, **VOLTS/THD**, and **AMPS/THD** buttons.

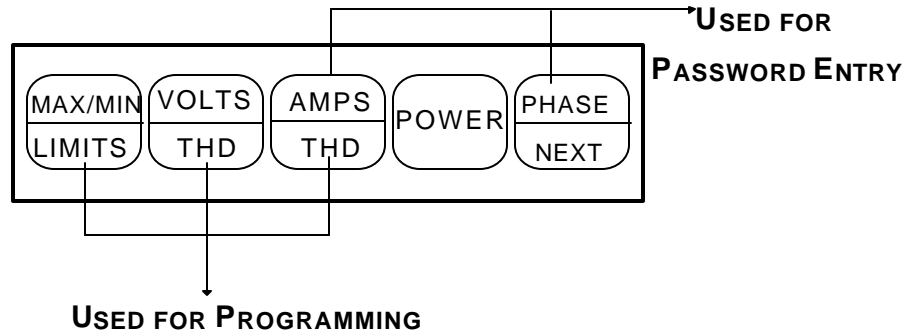

Note: The DMMS425 uses the same keypad strokes and methods. Although the keypad may look slightly different, the keys match the DMMS300+ exactly. In the interest of brevity, all keystrokes and programming functions are shown using the DMMS300+ keyboard.

BUTTON	FUNCTION	DESCRIPTION
MAX/MIN/LIMITS	ADVANCES	Scrolls GROUPS, FUNCTIONS and advances to exit point from FUNCTION and GROUP level.
VOLTS/THD	CHANGES VALUE	Scrolls PACKS, digit counters and changes switch PACK position UP or DOWN.
AMPS/THD	STORES	Activates new data entry and enters or exits from GROUP or FUNCTION level.

6.4: Standard Numeric Data Entry

Programmable FUNCTION values are always four digit numerical fields designed to accept any value between 0000 and 9999 (a blank signifies a zero). When entering the value of a FUNCTION, enter all four digits, leading zeros included. For instance, to enter the number 25, enter 0025.

CHAPTER 7

DMMS425

The DMMS425 is similar to the regular DMMS300+ with the following exceptions:

1. The size of the display digits is smaller (0.300" instead of 0.560").
2. The following features are not available:
 - The energy readings: VA/H, VAR/H.
 - The limits: Lim1 and Lim2, and dry contact relay outputs.
 - The harmonics readings: %THD and K-factor.
3. The layout of the keypad is slightly different (although the keys have exactly the same functions).

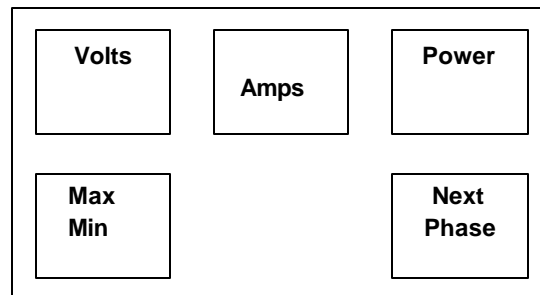

The DMMS425 Keypad

4. The unit's legend values are jumper-selectable: the user, if necessary, needs to open the cover and choose between V and KV, A and KA, Kilo (k) and Mega (M) for power relays.
5. The annunciators are highlighted one at a time.

NOTE: The Ethernet model, **DMMS350**, is covered in detail in Chapter 16 of this manual. See p. 36 for a comparison of the three models covered in this manual.

7.1: DMMS Model Comparison

DMMS300+ vs. DMMS425 vs. DMMS350

Feature	300+	425	350
Voltage 3-Phase	✓	✓	✓
Voltage Accuracy	0.2%	0.3%	0.2%
Current 3-Phase and Neutral	✓	✓	✓
Current Accuracy	0.2%	0.3%	0.2%
Watts, VARS, VA, PF	✓	✓	✓
Watts Accuracy	0.4%	0.6%	0.4%
Frequency	✓	✓	✓
Watt/HR	✓	✓	✓
VAR/HR (Optional)	✓		✓
VA/HR	✓		✓
Harmonics to 31 st Order	✓		✓
Feature	300+	425	350
Max/Min Demand	✓	✓	✓
Limits	✓		✓
Relays and Logic	✓		✓
Pulse Outputs	✓	✓	✓
Digital Communication	✓	✓	✓
Modbus RTU	✓	✓	
Modbus ASCII	✓	✓	
Analog Outputs	✓		
Modbus TCP			✓
Ethernet			✓

CHAPTER 8

ENTERING PROGRAMMING MODE

8.1: Checksum Error—Protective Self-Checking Algorithms

This checksum error is a protective self-checking wealth algorithm designed to alert the user when a procedure has not been correctly followed, ensuring that the meter does not display inaccurate readings.

If the control power is interrupted while in Programming Mode or the user does not completely exit, the meter enters a checksum mode. The max LED flashes. Press **AMPS** and **PHASE/NEXT** simultaneously and the unit recovers. Follow the procedure to enter Programming Mode to check program data. If the data is correct, then exit.

8.2: Password Entry

The DMMS300+ and 425 are password protected. To enter the Programming Mode, key in the following password: **555**.

The password entry may seem awkward at first. It is designed to be difficult to use initially. This secures unauthorized tampering. After you become familiar with password entry, you will find it quick and easy to accomplish.

NOTE: The meter will not store any programming unless properly exited (see Chapter 14 to Exit).

Entering Programming Mode:

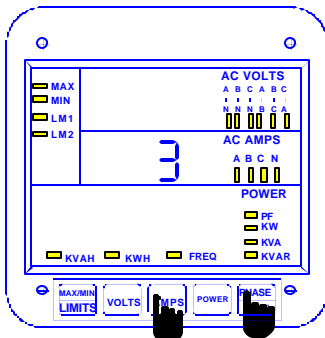

- Step 1:**
- Press and hold **PHASE/NEXT**.
 - While holding **PHASE/NEXT**, press **AMPS** until a number appears in middle display. Then **release** both buttons.
- ⇒ If **3** is not already displayed:
- Press **AMPS** until **3** appears.
 - Press **PHASE/NEXT** to multiply the **3** to **333**.
- ⇒ **333** flashes momentarily in middle display.

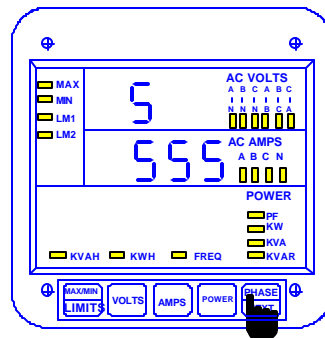

- Step 2:**
- ⇒ Digits begin scrolling in upper display.
- ☒ The password is **555**.
- Press **PHASE/NEXT** each time the digit **5** appears.
- ⇒ Selected digits appear in middle display.

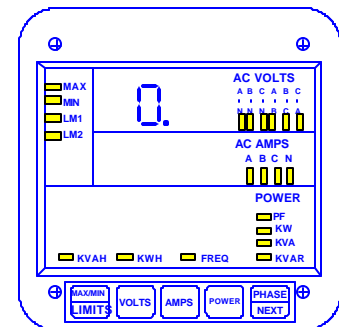

- ⇒ Display blanks and **PPP** flashes in upper display, confirming a correctly entered password.
- ⇒ **PPP** is replaced by **0.** and the meter is now in Programming Mode, GROUP 0.
- ⇒ You are now in the Programming Mode. CONGRATULATIONS!

NOTE: AUTO SCROLLING will automatically show all of the readings on the face of the meter except **LIMITS**. To **enter Auto Scrolling mode**, follow the above steps except use the numbers **666** as the password. To **exit Auto Scrolling mode**, use the same procedure as described above.

CHAPTER 9

PROGRAMMING GROUP 0 – GLOBAL METER SETUP

The Global Meter Setup includes FUNCTIONS 0 through 7 that control configuration and basic operation. FUNCTION 3 System Configuration contains Switch PACKS with various options, including Open Delta installation, communications or DC Output setup. Global Meter Setup is the section in which general features are programmed.

FUNCTION NUMBER	Function
0.	Integration Interval
1.	Meter Address for Communication
2.	Baud Rate for Communication
3.	System Configuration (see Table 9-2)
4.	Relay 1 Set-up / Time delay
5.	Relay 2 Set-up / Time delay
6.	KYZ Parameter Selection
7.	Number of Phases
E.	Exit Programming GROUP 0

Table 9-1: Group 0 Programming Format

9.1: Group 0, Function 0—The Integration Interval

INTEGRATION INTERVAL: Time which all instantaneous readings are averaged to obtain a max and min demand. The Integration Interval is entered in seconds. When entering 15 minutes, enter: 0900 seconds. The default value is 900 seconds.

To change the Integration Interval:

NOTE: Press **MAX/MIN/LIMITS** at any time to cancel before storing the last digit or switch.

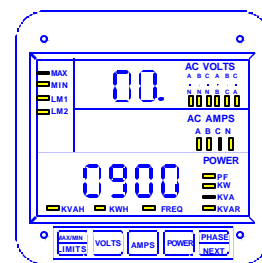
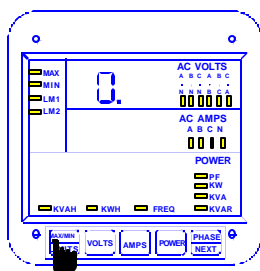

Step 1:

- Enter Group Level of Programming Mode (see Chp. 8).
- Press **MAX/MIN/LIMITS** until 0. appears in upper display.
- Press **AMPS** to activate the Group.

- ⇒ Function **00.** appears in upper display. The second **0** indicates Function 0
- ⇒ Lower display indicates current Interval setting.

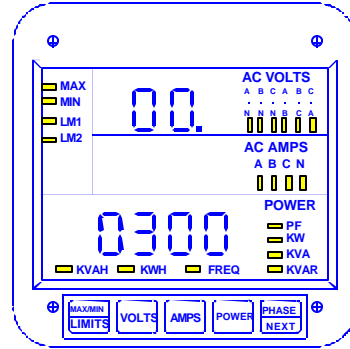
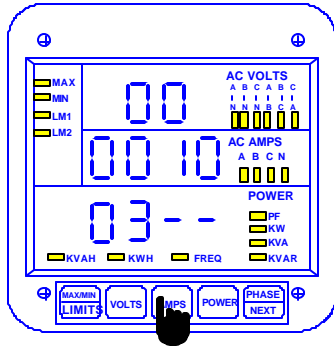

Step 2:

a. Press **AMPS** once to begin Data Entry Sequence.

⇒ The previous value shifts to middle display and four dashes appear in lower display.

b. Press **VOLTS** for desired number.

c. Press **AMPS** to store.

⇒ Repeat this procedure until new Integration Interval is entered.

⇒ When complete, middle display blanks and lower display indicates new Integration Interval.

See Chapter 14 to Exit.

9.2: Group 0, Function 1—The Meter Address

METER ADDRESS: Identifies the meter when communicating with digital communications. When numerous meters are at one site, it is essential that each meter have its own address. Otherwise, all meters speak at the same time and communication is useless.

To change the Meter Address:

NOTE: Press **MAX/MIN/LIMITS** at any time to cancel before storing the last digit or switch.

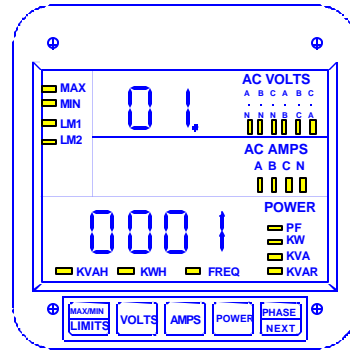
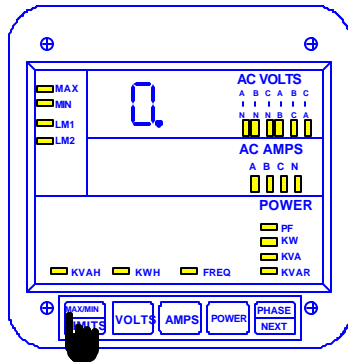

Step 1:

a. Enter Group Level of Programming Mode (see Chp. 8).

b. Press **MAX/MIN/LIMITS** until **0.** appears.

c. Press **AMPS** to activate the Group.

Step 2:

a. Press **MAX/MIN/LIMITS** until Function **01.** appears in upper display.

⇒ Lower display indicates the current Meter Address.

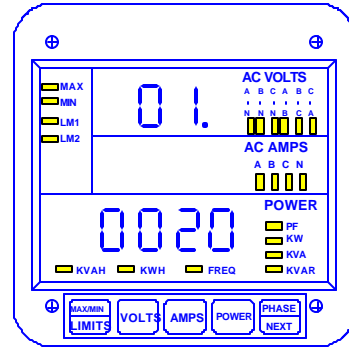
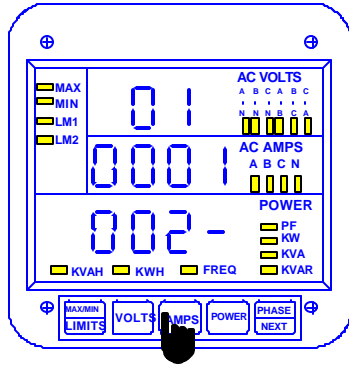

Step 3:

a. Press **AMPS** once to begin Data Entry Sequence.

⇒ The previous value shifts to middle display and four dashes appear in lower display.

b. Press **VOLTS** for desired number.

c. Press **AMPS** to store each digit.

⇒ Repeat this procedure until new Address is entered.

⇒ When complete, middle display blanks and lower display indicates new Address.

See Chapter 14 to Exit.

9.3: Group 0, Function 2—BAUD RATE

BAUD RATE: Speed at which data is transmitted between meter and remote computer or serial printer. The rate programmed into the meter must match the rate used by the remote device. Valid Baud Rates are 1200, 2400, 4800 and 9600.

To change the Baud Rate:

NOTE: Press **MAX/MIN/LIMITS** at any time to cancel before storing the last digit or switch.

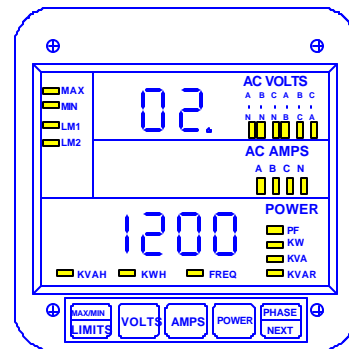
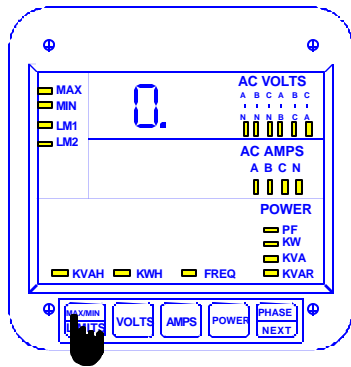

Step 1:

a. Enter Group Level of Programming Mode (see Chp. 8).

b. Press **MAX/MIN/LIMITS** until 0. appears.

c. Press **AMPS** to activate the Group.

Step 2:

a. Press **MAX/MIN/LIMITS** until Function 02. appears in upper display.

⇒ Lower display indicates current Baud Rate.

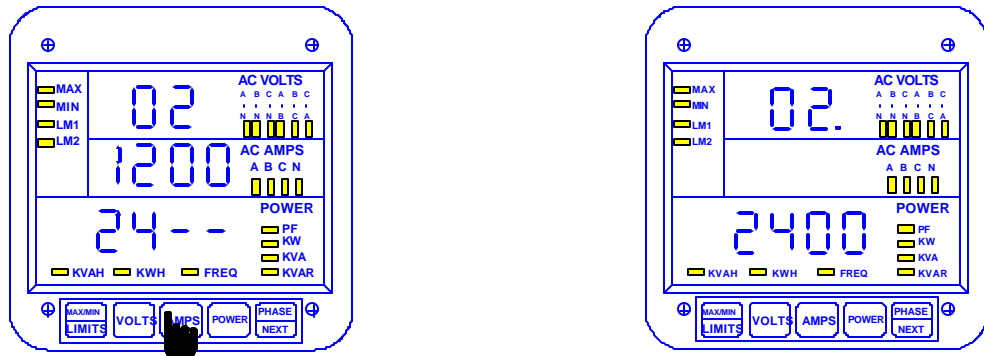

Step 3:

a. Press **AMPS** to begin Data Entry Sequence.

⇒ The previous value shifts to middle display and four dashes appear in lower display.

b. Press **VOLTS** for desired number.

c. Press **AMPS** to store each digit.

⇒ Repeat this procedure until new Communication Baud Rate is entered.

⇒ When complete, middle display blanks and lower display indicates new Baud Rate.

See Chapter 14 to Exit.

9.4: Group 0, Function 3—System Configuration

The System Configuration sets the DMMS300+'s basic operational parameters. This Function utilizes Switch PACKS.

FUNCTION 3 contains four different Switch PACKS: 0–3. Each PACK contains four individual UP/DOWN segments.

- Toggling the segment between UP and DOWN, toggles the switch ON or OFF, or chooses between two options.
- The meter displays one Switch PACK at a time.

⇒ Press **VOLTS** to scroll from PACK to PACK.

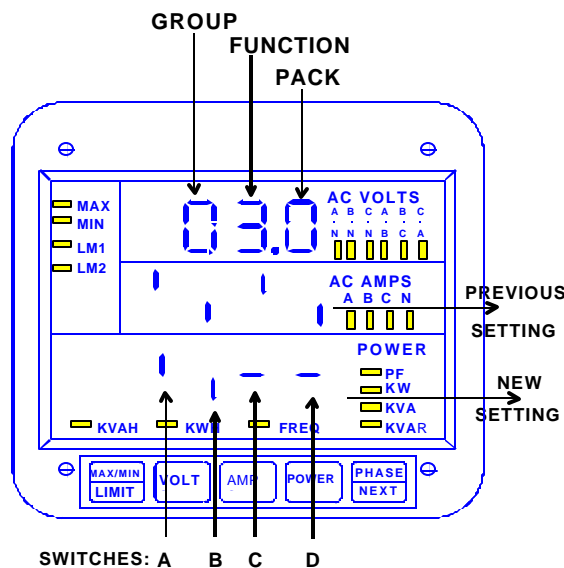

PACK	SWITCH	FEATURE	SEGMENT POSITION
0	A	Reserved	—
	B	Reserved	—
	C	Reserved	—
	D	Phase Reversal Limit Detection	UP: Enable DOWN: Disable
1	A	Non-significant will blank leading zero	UP: Enable DOWN: Disable
	B	Reset Protection (see Part I: Installation and Operation)	UP: Enable DOWN: Disable
	C	Phase Reversal Rotation Selection	UP: CBA Rotation DOWN: ABC Rotation
	D	Open Delta Installation (see Part I: Installation and Operation)	UP: Enable DOWN: Disable
2	A	Limit/Relay Control	UP: Average DOWN: Instantaneous
	B	Power Factor Polarity Indicates + (voltage referenced) or - (current referenced)	UP: -PF DOWN: +PF
	C, D	For EI-BUS protocol: Switch C is DOWN, Switch D is DOWN. For MODBUS protocol, ASCII framing: Switch C is UP, Switch D is UP. For MODBUS protocol, RTU framing: Switch C is DOWN Switch D is UP. For DNP 3.0 protocol: Switch C is UP, Switch D is DOWN.	
3	A	Trip Relay Computer Control 1 (Relay Control 1 and 2 apply only if Relay Option -NL was ordered.)	UP: Enable DOWN: Disable
	B	Trip Relay Computer Control 2 (Relay Control 1 and 2 apply only if Relay Option -NL was ordered.)	UP: Enable DOWN: Disable
	C	RS-232 or RS-485 Communications or Print	UP: Enable Communications DOWN: Enable DC Output
	D	DC Output (To operate DC Output, disable PACK 3, Switch C) or Print Operating and Programming Data (To print, set PACK 3 Switches C and D to UP position.)	UP: Enable DC Output or Print Communication DOWN: Disable DC Output and Print

Table 9-2: System Configuration—Switch Packs for Group 0, Function 3

OPEN DELTA SYSTEM INSTALLATION PROGRAMMING

A special switch is used to indicate that the electrical system being monitored is a Three-phase WYE or Three-Wire Open Delta System using the connection installation (see Chapter 3). The switch is located in GROUP 0, FUNCTION 3, Pack 1, Switch D.

WARNING: *This switch should be set to UP only if the electrical system is a Three-Wire Delta or Open Delta, using 2 PTs. Otherwise, the switch should be set to DOWN. Failure to select this switch results in Phase-to-Neutral readings, as well as incorrect power readings, with the 2PT connection.*

Special Open Delta Connection Installation should be followed in the Installation and Operation section (Chapter 3).

SWITCHING COMMUNICATION PROTOCOLS, EI-BUS, MODBUS RTU/ASCII, DNP 3.0

- For EI-BUS protocol: PACK 2, Switch C is DOWN, Switch D is DOWN.
- For MODBUS protocol, ASCII framing: PACK 2, Switch C is UP, Switch D is UP.
- For MODBUS protocol, RTU framing: PACK 2, Switch C is DOWN Switch D is UP.
- For DNP 3.0 protocol: PACK 2, Switch C is UP, Switch D is DOWN.

NOTE: *When programming for MODBUS protocol configuration of LIPA (Long Island Power Authority) mapping options may be performed through communication.*

9.5 Modbus Plus Capability

When using the MPI Modbus Plus adapter, the meter values should be set to speak to Modbus RTU with a meter address of 0001 and a baud rate of 9600 baud. The Modbus Plus address is programmed into the MP1 Modbus Plus adapter directly.

PRINTING OPTION

To print, access Mode 1 and Mode 2 (see Part I: Installation and Operation). Printing serial options should be disabled when using a multimeter communications connection RS485.

- DISABLING PREVENTS:**
1. Printing through the keypad.
 2. Corrupting data at a computer terminal while multiple meters poll.
 3. Corrupting printing commands through communications.

This option connects a serial printer to the RS232 port and prints the data. Disable this feature when the meter is not using an RS232 port (i.e., when RS485 or DC outputs are being used).

9.6: Group 0, Function 3—Programming Procedure

To change the System Configuration Switch Settings:

NOTE: Press **MAX/MIN/LIMITS**, at any time, to cancel before storing the last digit or switch.

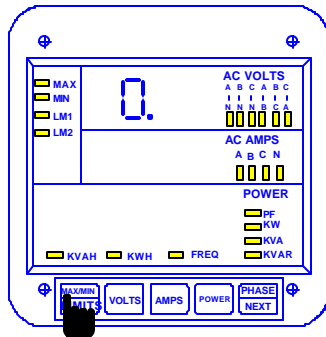

Step 1:

- Enter Group Level of Programming Mode (see Chp. 8).
- Press **MAX/MIN/LIMITS** until **0.** appears in upper display.
- Press **AMPS** to activate the Group.

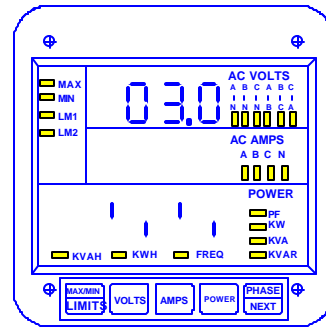

Step 2:

- Press **MAX/MIN/LIMITS** until Function **03.0** appears in upper display.
⇒ Lower display indicates current PACK 0 Switch Settings.

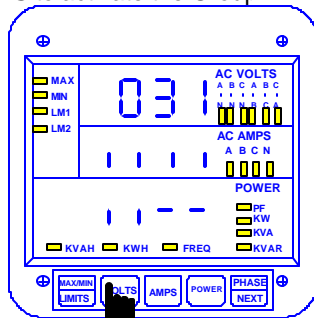

Step 3:

- Press **VOLTS** until desired PACK appears.
- Press **AMPS** to begin Data Entry Sequence.
⇒ The previous Switch settings shift to middle display and four dashes appear in lower display.
- Press **VOLTS** to toggle the segments up or down for desired setting.
- Press **AMPS** to store each setting.

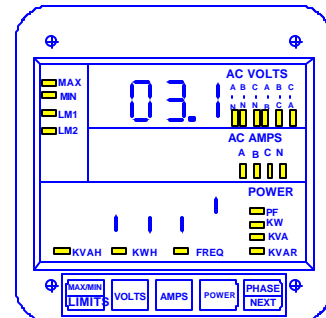

- ⇒ Repeat procedure until new Switch Setting is entered.
⇒ The middle display blanks and new Switch Settings are indicated on lower display.

(This example shows enabling of Open Delta Installation switch).

See Chapter 14 to Exit.

9.7: Relay Mode

NOTE: Relays are not available for the DMMS425.

SWITCH	DESCRIPTION	Segment Position
A	Reversal Imbalance Control	UP⇒Enable DOWN⇒Disable
B	AND/OR Logic	UP⇒AND DOWN⇒OR
C & D	Relay Control	see Table 8-4

Table 9-3: SWITCH PACKS for 04P & 05P

The Switch PACKS in FUNCTIONS 4 and 5 of programming GROUP 0 control the relay position. Setting the switches in different combinations allows the user to specify the conditions in which the relay will be “SET” or “RESET.” The following table indicates possible configurations.

SWITCH C	SWITCH D	DESCRIPTION
UP	UP	FAIL-SAFE MODE —The normal or non-event condition is set. RESET relay on either out of limit condition. Relay acts as a protective switch if power is interrupted. This alerts the user if the meter or the meter power is out.
UP	DOWN	N/A (Reserved for future features).
DOWN	UP	N/A (Reserved for future features).
DOWN	DOWN	RESET MODE —The normal or non-event condition is reset. SET relay on either out of limit condition.

Table 9-4

DEFINITIONS:

RESET: There is a short between “COM” and “N.C.” (Normally closed)

SET: There is a short between “COM” and “N.O.” (Normally open)

(See Part I: Installation and Operation.)

Example 1: Fail-safe mode normally set—non-event condition is set relay

Relay 1 will be “SET” if the instantaneous reading for frequency is between 58 Hz and 62 Hz. When all other conditions exist, the relay will “RESET.”

NOTE: Under this setup the relay acts as a protective switch.

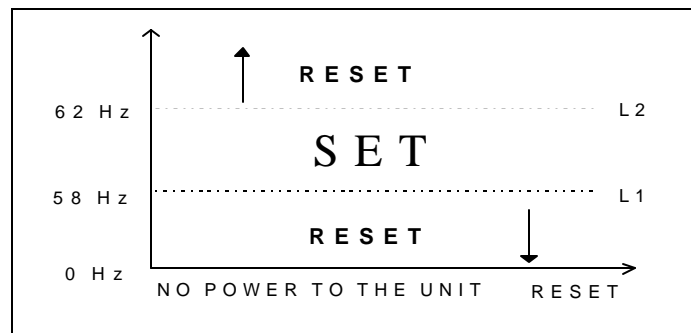

PROGRAMMING STEPS:

1. Enter in GROUP 0, FUNCTION 4, PACK 'P', Segment C and D: UP, UP.
2. Enter in GROUP 5, FUNCTION 4, LIMIT 1, Segments B, C, and D: DOWN, UP, DOWN. Value: 58.00.
3. Enter in GROUP 5, FUNCTION 4, LIMIT 2, Segments B, C, and D: UP, UP, DOWN. Value: 62.00.

Example 2: Normally reset—non-event condition is reset relay

Relay 1 will be "SET" if the instantaneous reading for amps is below 4.00 or above 5.00 amps. Under all other conditions the relay will be "RESET".

NOTE: Under this setup the relay will NOT act as a protective switch.

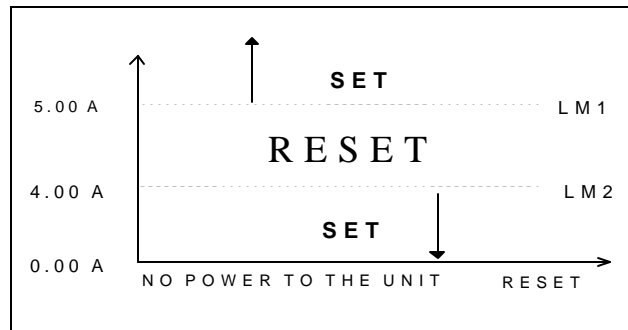

PROGRAMMING STEPS:

1. Enter in GROUP 0, FUNCTION 4, PACK 'p', Segments C and D: DOWN, DOWN
2. Enter in GROUP 4, FUNCTION 2, LIMIT 1, Segments: B, C, and D: UP, UP, DOWN. Value: 5.00
3. Enter in GROUP 4, FUNCTION 2, LIMIT 2, Segments: DOWN, UP, DOWN. Value: 4.00

GROUP 0—FUNCTION NUMBER	DESCRIPTION
04.P	Controls Relay 1
05.P	Controls Relay 2 (and 3 if NL4)

Relay Mode: Group 0, Functions 4–5

To change the Relay Mode to either Fail-safe or Reset:

NOTE: Press **MAX/MIN/LIMITS** at any time to cancel before storing the last digit or switch.

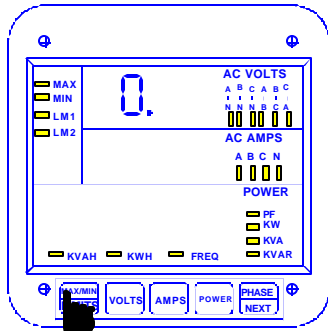

Step 1:

- a. Enter Group Level of Programming Mode (see Chp. 8).
- b. Press **MAX/MIN/LIMITS** until **0.** appears in upper display.
- c. Press **AMPS** to activate the Group.

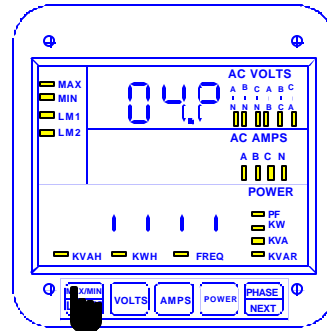

Step 2:

- a. Press **MAX/MIN/LIMITS** until **04.P** (for Relay 1) or **05.P** (for Relay 2) appears in upper display.
- ⇒ Lower display indicates current setting.

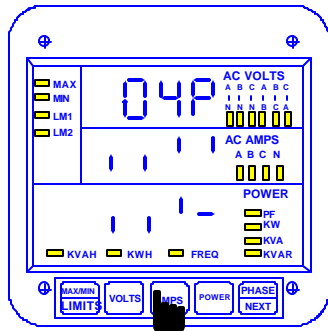

Step 3:

- a. Press **AMPS** to begin Data Entry Sequence.

⇒ The previous setting shifts to middle display and four dashes appear in lower display.
- b. Press **VOLTS** for desired switch position.
- c. Press **AMPS** to store each setting.

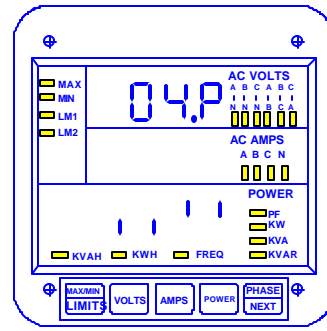

- ⇒ Repeat this procedure until new switch setting is entered.
- ⇒ When complete, middle display blanks and lower display indicates the programming.

See Chapter 14 to Exit.

9.8: Group 0, Functions 4–5—Time Delay for Relays 1 and 2 (Option – NL)

GROUP 0, FUNCTIONS 4–5 sets the time delay for Relays 1 and 2 between 0 and 255 seconds. This allows conditions (example below) to exist for a user-specified time period before the relay or alarm activates. If a time greater than 255 seconds is entered, the meter defaults to the maximum value of 255 seconds.

Example: If Relay 1 is set for 300 amps and the amps increase to 301, the Relay trips only after a programmed delay period. If the meter then measures 299 Amps, the Relay returns to its original position, after the programmed delay.

Relay 1: Located in 04.0 & 04.1.

Relay 2: Located in 05.0 & 05.1.

(Procedures for both relays are the same).

GROUP AND FUNCTION NUMBER	DESCRIPTION
04.0	Relay 1: On to Off Delay Time
04.1	Relay 1: Off to On Delay Time
05.0	Relay 2: On to Off Delay Time
05.1	Relay 2: Off to On Delay Time

To change Time Delays:

NOTE: Press **MAX/MIN/LIMITS** at any time, to cancel before storing the last digit or Switch.

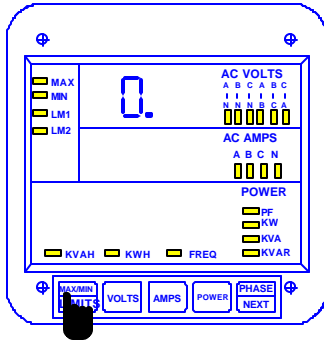

- Step 1:**
- Enter Group Level of Programming Mode (see Chp. 8).
 - Press **MAX/MIN/LIMITS** until **0.** appears in upper display.
 - Press **AMPS** to activate the Group.

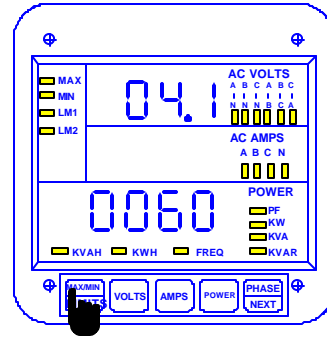

- Step 2:**
- To program Relay 1:**
- Press **MAX/MIN/LIMITS** until Function **04.P** appears in upper display.
- To program Relay 2 and 3:**
- Press **MAX/MIN/LIMITS** until Function **05.P** appears.
 - Press **VOLTS** once to display **04.0** (On to Off delay time).
 - Press **VOLTS** twice to display **04.1** (Off to On delay time).
- ⇒ Lower display indicates current Time Delays.

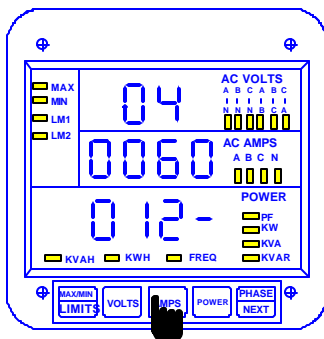

- Step 3:**
- Press **AMPS** to begin Data Entry Sequence.

⇒ The previous value shifts to middle display and four dashes appear in lower display.
 - Press **VOLTS** until number appears.
 - Press **AMPS** to store each number.

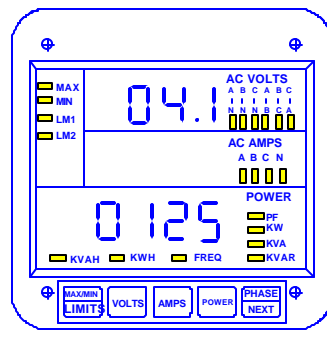

- ⇒ Repeat this procedure until new Time Delay is entered.
- ⇒ When complete, middle display blanks and lower display
- Indicates the new Time Delay.
- See Chapter 14 to Exit.

9.9: Group 0, Function 6—KYZ Parameter Selection

NOTE: FUNCTION 6 applies only if Option -NL or -NL2 was ordered.

OPTION -NL: This option gives the meter 2 Relays and one KYZ pulse. The KYZ pulse can be programmed to the below features.

Select a single parameter from **Table 9-5** according to the DMMS300+ model being programmed.

OPTION -NL2: This option offers 3 distinct KYZ pulses instead of Relays. Only three separate parameters may be selected: FUNCTION 6.0 (KYZ Port 0), FUNCTION 6.1 (KYZ Port 1), and FUNCTION 6.2 (KYZ Port 2). The available parameters vary according to the DMMS300+ model being programmed. For exact port positions see Installation Sections.

PARAMETER	DESCRIPTION
0	Disable KYZ
1	Positive Watt Hour KYZ
2	VA Hour KYZ
3	Negative Watt Hour KYZ
4	Positive VAR Hour KYZ
5	Negative VAR Hour KYZ

Table 9-5: KYZ Parameters

APPLICABLE SELECTIONS: 300+ - +WH, -WH, VAH
 300+R* - +WH, -WH, +VARH, -VARH
 * (-R option gives the 300+ VAR/Hour readings instead of VA/Hours).

To perform the KYZ Parameter Selection:

NOTE: Press **MAX/MIN/LIMITS** at any time to cancel before storing the last digit or switch.

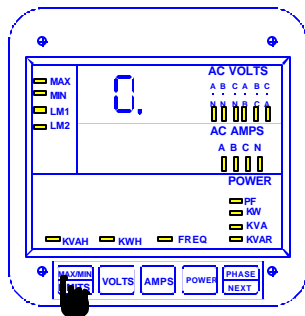

- Step 1:**
- Enter Group Level of Programming Mode (see Chp. 8).
 - Press **MAX/MIN/LIMITS** until **0.** appears in upper display.
 - Press **AMPS** to activate the Group.

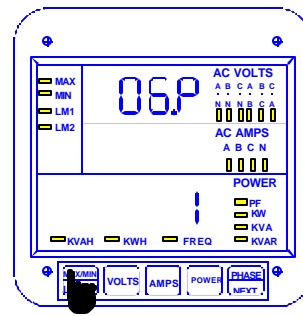

- Step 2:**
- Press **MAX/MIN/LIMITS** until **06.P** appears in upper display.
 (Standard Selection is 1).

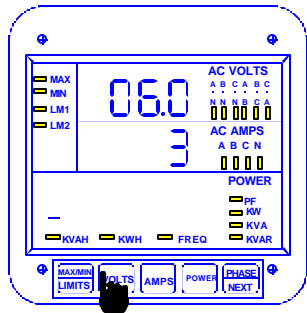

Step 3:

a. Press **VOLTS** once and **06.0** appears in upper display.

⇒ Middle display indicates preset value.

⇒ Lower display indicates polarity of selected parameter and an annunciator indicates the selected parameter.

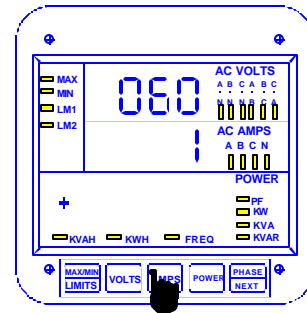

Step 4:

a. Press **AMPS** once to select a different parameter.

b. Press **MAX/MIN/LIMITS** to increase the parameter number

—or—

c. Press **VOLTS** to decrease (until desired parameter appears).

d. Press **AMPS** to store.

⇒ A decimal appears in upper level. (Models with -NL Option, FUNCTION 6 is complete).

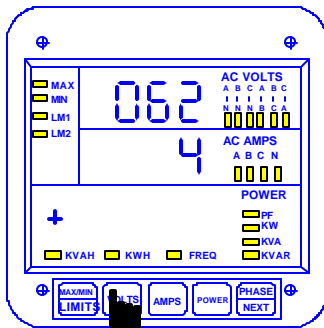

APPLIES TO -NL2 OPTION ONLY:

Step 5:

a. Press **VOLTS** to proceed to another port (06.1 or 06.2).

⇒ Repeat this procedure to change parameters.

See Chapter 14 to Exit.

SELECTION IN 06P	KYZ PULSE VALUE PER WATT HOUR FSW=9999.	KYZ PULSE VALUE PER WATT HOUR FSW=999.9	KYZ PULSE VALUE PER WATT HOUR FSW=99.99	KYZ PULSE VALUE PER WATT HOUR FSW=9.999
Multiply by 1	1.0 unit WH	0.1 unit WH	0.01 unit WH	0.001 unit WH
Multiply by 2	0.5 unit WH [†]	0.05 unit WH [†]	0.005 unit WH	0.0005 unit WH
Multiply by 10	0.1 unit WH	0.01 unit WH	0.001 unit WH	0.0001 unit WH
Multiply by 20	0.05 unit WH	0.005 unit WH	0.0005 unit WH [†]	0.00005 unit WH [†]
Divide by 1	1.0 unit WH	0.1 unit WH	0.01 unit WH	0.001 unit WH
Divide by 2	2.0 unit WH	0.2 unit WH	0.02 unit WH	0.002 unit WH
Divide by 10	10.0 unit WH [†]	1.0 unit WH [†]	0.1 unit WH	0.01 unit WH
Divide by 20	20.0 unit WH	2.0 unit WH	0.2 unit WH [‡]	0.02 unit WH [‡]

Table 9-6: KYZ Pulse Value

NOTE: The unit WH refers to the counter value on the meter, where the unit equals Kilo or Mega user-defined.

The FSW number is used only for decimal point placement (see Chapter 10).

HOW TO USE KYZ PULSE VALUE TABLE FOR MULTIPLICATION:

SITUATION 1: FSW=9999.

- Selection is Multiply by 2
- This means that every .5 unit WH =1 pulse.
- Unit=Kilo (see Group 1, Function 2)
- Result: For every 1 KWH increment on the counter, the meter will output 2 pulses.

SITUATION 3: FSW=99.99

- Selection is Multiply by 20
- This means that every .0005 unit WH=1 pulse.
- Unit=Kilo (see Group 1, Function 2)
- Result: For every 1 KWH increment on the counter, the meter will output 2,000 pulses.

SITUATION 2: FSW=999.9

- Selection is Multiply by 2
- This means that every .05 unit WH=1 pulse.
- Unit=Kilo (see Group 1, Function 2)
- Result: For every 1 KWH increment on the counter, the meter will output 20 pulses.

SITUATION 4: FSW=9.999

- Selection is Multiply by 20
- Unit=Kilo (see Group 1, Function 2)
- This means that every .00005 WH=1 pulse.
- Result: For every 1 KWH increment on the counter, the meter will output 20,000 pulses.

HOW TO USE THE KYZ PULSE VALUE TABLE FOR DIVISION:

SITUATION 1: FSW=9999.

- Selection is Divide by 10
- This means that every 10 unit WH=1 pulse.
- Unit=Kilo (see Group 1, Function 2)
- Result: For every 10 KWH increment on the counter, the meter will output 1 pulse.

SITUATION 3: FSW=99.99

- Selection is Divide by 20
- This means that every .2 unit WH=1 pulse.
- Unit=Kilo (see Group 1, Function 2)
- Result: For every 1 KWH increment on the counter, the meter will output 5 pulses.

SITUATION 2: FSW=999.9

- Selection is Divide by 10
- This means that every 1 unit WH=1 pulse.
- Unit=Kilo (see Group 1, Function 2)
- Result: For every 1 KWH increment on the counter, the meter will output 1 pulse.

SITUATION 4: FSW=9.999

- Selection is Divide by 20
- Unit=Kilo (see Group 1, Function 2)
- This means that every .02 WH=1 pulse.
- Result: For every 1 KWH increment on the counter, the meter will output 50 pulses.

To change the KYZ pulse value:

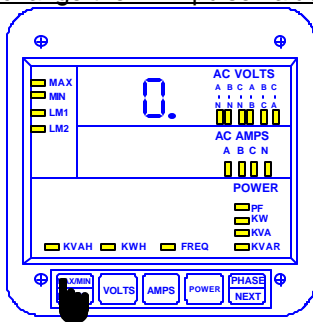

Step 1:

- Enter Group Level of Programming Mode, (see Chp. 8).
- Press **MAX/MIN/LIMITS** until **0.** appears in upper display.
- Press **AMPS** to activate the Group.

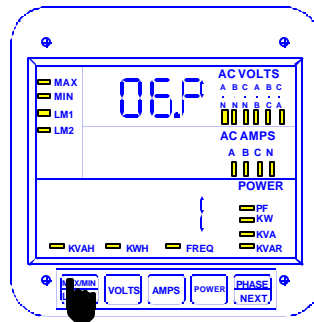

Step 2:

- Press **MAX/MIN/LIMITS** until **06.P** appears in upper display.
 - ⇒ The lower display indicates multiplication or division factor.

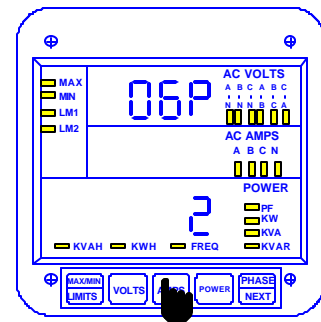

Step 3:

- Press **AMPS** to change current setting.
 - ⇒ The decimal point next to the 6 disappears.
- Press **MAX/MIN/LIMITS** to advance selections. -or-
- Press **VOLTS** to reverse. (Until desired factor appears).
 - ⇒ Division is indicated by div appearing in the middle display. When middle display is blank, it indicates multiplication.
- Press **AMPS** to store.

9.10: Group 0, Function 7—Number of Phases

NOTE: ENTER 1 FOR SINGLE PHASE/SINGLE WIRE.
 ENTER 2 FOR SINGLE PHASE/TWO WIRE.
 ENTER 3 FOR THREE PHASE/THREE OR FOUR WIRE.

- *STANDARD FACTORY SET-UP IS THREE-PHASE FOUR-WIRE

Note: Press **MAX/MIN/LIMITS** at any time to cancel before storing the last digit or switch.

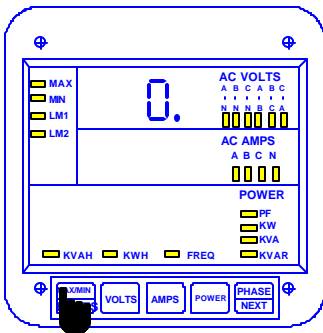

- Step 1:**
- Enter Group Level of Programming Mode. (Chapter 8)
 - Press **MAX/MIN/LIMITS** if 0. does not appear.
 - Press **AMPS** to activate the Group.

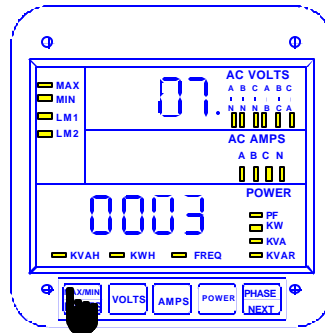

- Step 2:**
- ⇒ 00. appears in upper display.
- Press **MAX/MIN/LIMITS** until 07 appears in upper display.
 - Press **AMPS** to activate the Group.

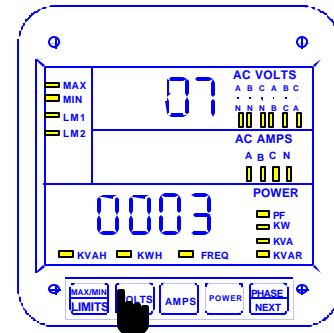

- Step 3:**
- Press **VOLTS** to select numbers 1, 2 or 3.
 - Press **AMPS** to store.
- See Chapter 14 to Exit.

CHAPTER 10

PROGRAMMING GROUP 1 – VOLTAGE, AMP AND WATT SCALE SETTINGS

NOTE: The DMMS300+ and 425 full scales will already be programmed if the order specified current and voltage transformer ratios. The meter label indicates any full scale setup.

Programming Group 1 contains voltage, amperage and full scale power selection, along with scale factor selection and decimal point placement.

The user can re-scale without removing the DMMS300+ for calibration. The DMMS300+ has been calibrated at standard levels in GROUP 2. Mathematically convert any full scale ratios to those calibrated levels. If a different current or voltage transformer is used, program the primary value of its ratio. If necessary, convert the ratio to a secondary value of five amps standard current (1 amp is a special order) and 120V or 75V nominal voltage (options L only).

FORMULAS:

$$\frac{\text{Primary}}{\text{Secondary}} \times 120V$$

$$\frac{\text{Primary}}{\text{Secondary}} \times 75V$$

$$\frac{\text{Primary}}{\text{Secondary}} \times 5A$$

It may be necessary to convert the full scale to a larger unit. There is a resolution limitation for all full scales of 2000. If a display reading exceeds 2000, it may be unstable and subject to zeroing problems.

Example: The full scale for a CT ratio of 3000/5 should be 03.00 kA.

When changing a PT or CT full scale, calculate the new watts full scale and make any necessary changes. The watts full scale will not auto range.

10.1: Group 1, Function 0—Full Scale Voltage Settings, Scale & Decimal Point Placement

GROUP AND FUNCTION NUMBER	FUNCTION
10.	Full Scale Selection for Volts
11.	Full Scale Selection for Amps
12.	Full Scale Selection for Watts
1E.	Exit Programming GROUP 1

Table 10-1: Group 1 Programming Format

NOTE: Tables 10-2 and 10-3 contain Full Scale Settings for typical voltages and currents (PT and CT arrangements).

SECONDARY PT VALUES	PT RATIO	FULL SCALE
75 V (Suffix 75) L-N MAX	120:1	9.00 KV
120/208 V	1:1 (Direct)	120.0
120/208 V	4:1	0480 V
120/208 V	120:1	014.4 KV
277/480 V (Suffix G)	1:1 (Direct)	0300 V
120/208V	600:1	072.0 KV
120/208	1150:1	138.0 KV

Table 10-2: TYPICAL Full Scale Settings for Volts

If PT is connected line to line, the full scale can be 14.40 KV. Full scale is **300 V** L-N, not 277, because the factory calibration is 300 V. Be sure the table is based on a meter regulation of 2000 A/D counts. Thus, for best accuracy, all settings should be placed within that range.

VOLTAGE FULL SCALE:

To change the Full Scale Settings:

NOTE: Press **MAX/MIN/LIMITS** at any time to cancel before storing the last digit or switch.

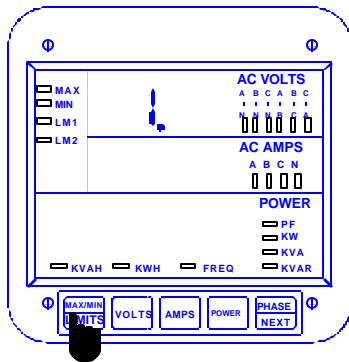

- Step 1:**
- Enter Group Level of Programming Mode (see Chp. 8).
 - Press **MAX/MIN/LIMITS** until **1.** appears in upper display.

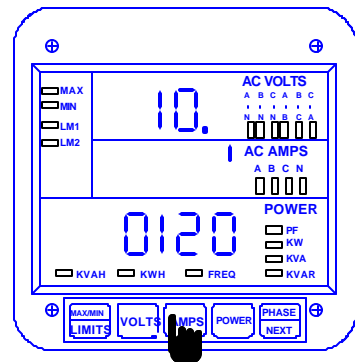

- Step 2:**
- Press **AMPS** to activate GROUP 1.
 - ⇒ **10.** appears in upper display.
 - ⇒ Middle display indicates Scale Factor Setting.
 - ⇒ Lower display indicates Full Scale for voltage.

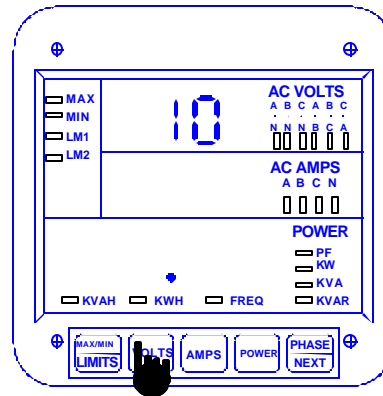
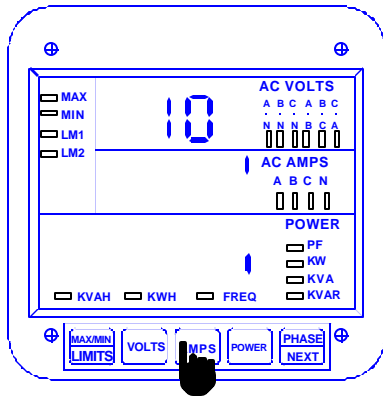

ENTERING THE SCALE FACTOR:

Step 3:

a. Press **AMPS** to begin Data Entry Sequence.

⇒ Lower display is replaced with a single dash.

b. Press **VOLTS** to move the segment UP or DOWN to set Scale Factor.

⇒ UP signifies - *Kilovolts*

⇒ DOWN signifies - *Volts*

c. Press **AMPS** to store.

DECIMAL POINT SELECTION:

Step 4:

a. Press **VOLTS** to move decimal point.

b. Press **AMPS** to store.

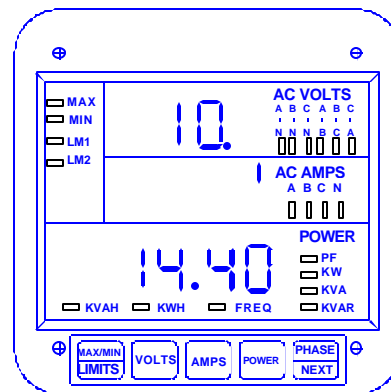
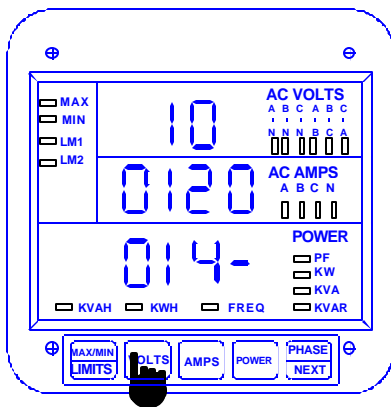

Step 5:

⇒ Middle display indicates present Full Scale for volts.

⇒ Four dashes appear in lower display.

⇒ Enter the four digit full scale.

a. Press **VOLTS** to increase the digit number.

b. Press **AMPS** to store each digit.

⇒ Repeat this procedure until desired value is entered.

⇒ Lower display indicates new Full Scale Setting.

⇒ Middle display indicates Scale Factor.

⇒ Group and Function Number (including decimal point) appear in upper display.

See Chapter 14 to exit.

10.2: Group 1, Function 1—Amperage Full Scale

CT TYPE	FULL SCALE
Direct Input	05.00 A
600/5	0600 A
1000/5	1000 A
2000/5	2000 A
3000/5	03.00 KA
5000/5	05.00 KA

Table 10-3: Full Scale Settings for Amps

Also note that the meter reads with digital accuracy to a 2000 count range. Thus all CT and PT full scale settings in the meter should reflect that limitation. The table above shows the proper settings.

To change the Full Scale Settings:

NOTE: Press **MAX/MIN/LIMITS** at any time to cancel before storing the last digit or switch.

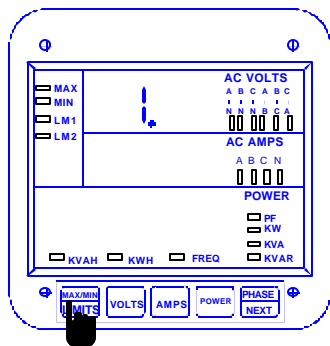

Step 1:

- Enter Group Level of Programming Mode (see Chp. 8).
- Press **MAX/MIN/LIMITS** until **1.** appears in upper display.

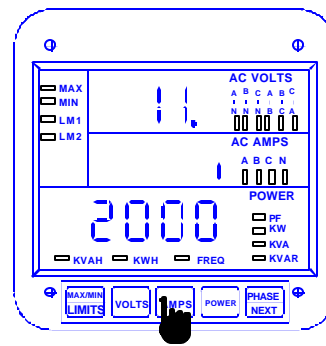

Step 2:

- Press **AMPS** to activate the Group.
- Press **MAX/MIN/LIMITS** until **11.** appears in upper display.
 - ⇒ Middle display indicates Scale Factor Setting.
 - ⇒ Lower display indicates Full Scale.

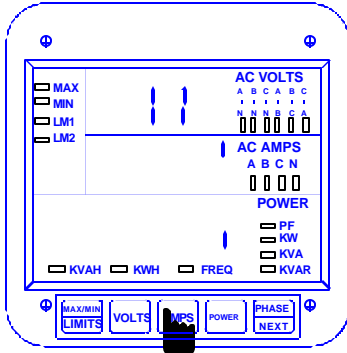

ENTERING THE SCALE FACTOR:

Step 3:

- Press **AMPS** to begin Data Entry Sequence.
⇒ Lower display is replaced with a single dash.
- Press **VOLTS** to move the segment UP or DOWN to set Scale Factor.
⇒ UP signifies - *Kiloamps*.
⇒ DOWN signifies - *Amps*.
- Press **AMPS** to store.

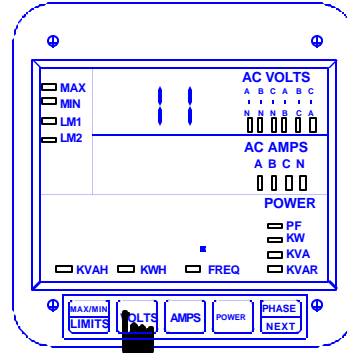

DECIMAL POINT SELECTION:

Step 4:

- Press **VOLTS** to move decimal point.
- Press **AMPS** to store.

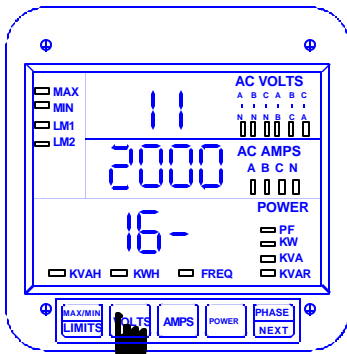

Step 5:

- The Full Scale for current is indicated in middle display.
⇒ Four dashes appear in lower display.
⇒ Enter the four digit full scale.
Press **VOLTS** until the number appears.
- Press **AMPS** to store.

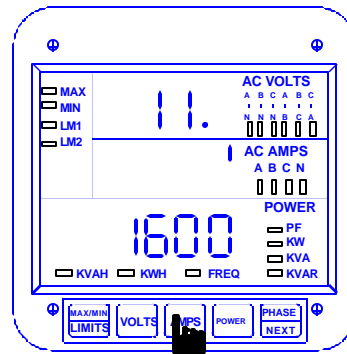

- Repeat this procedure until the value is entered.
⇒ Lower display indicates new Full Scale Setting.
⇒ Middle display indicates Scale Factor.
Group and Function Number appear (including a decimal point) in upper display.

10.3: Group 1, Function 2—Scale Selection and Decimal Placement for Watts

Programming GROUP 1 also provides decimal positioning for maximum resolution. The following examples assist in selecting the best decimal position for FUNCTION 2.

NOTE: Shift the decimal left to increase resolution. Wattage should not exceed a numeral value of 2500. Shift the decimal one position right to decrease resolution.

Full Scale Wattage (FSW) is the product of FSV and FSA. For FSW for three phases multiply the FSW per phase by 3.

Example 1: Full Scale Voltage (FSV)=120 V
Full Scale Amperage (FSA)=5.00 A

$$\begin{aligned} \text{FSW (one phase)} &= 120 \text{ V} \times 5.00 \text{ A} \\ \text{FSW (one phase)} &= 600 \text{ W} \\ \text{FSW (three phase)} &= 600 \text{ W} \times 3 = 1,800 \text{ W} \end{aligned}$$

Here the FSW is too small a value for a Megawatt meter. FSW in the Kilowatt meter equals 1.800 KW. In FUNCTION 2, four 9s appear. Place the decimal point after the first digit. The user cannot change the four digits. The user can only move the decimal point placement.

Example 2: 480/120 PT, 1000/5 CT

FSV=480 V
FSA=1000 A

$$\begin{aligned} \text{FSW (one phase)} &= 480 \text{ V} \cdot 1000 \text{ A} \\ \text{FSW (one phase)} &= 480,000 \text{ W} \\ \text{FSW (three phase)} &= 480,000 \text{ W} \times 3 = 1,440,000 \text{ W} \end{aligned}$$

FSW for a Kilowatt meter equals 1440. KW. FSW for a Megawatt meter equals 1.440 MW. In FUNCTION 2 place the decimal point after the last digit for a Kilowatt meter and after the first digit for a Megawatt meter. It is important to note which type of bezel labeling you have when making this decision.

Example 3: 14.4 KV/120, 1000/5 CT

FSV=14.40 KV
FSA=1000 A

$$\begin{aligned} \text{FSW (one phase)} &= 14,400 \text{ V} \times 1000 \text{ A} \\ \text{FSW (one phase)} &= 14,400,000 \text{ W} \\ \text{FSW (three phase)} &= 14,400,000 \text{ W} \times 3 = 43,200,000 \text{ W} \end{aligned}$$

FSW for a Kilowatt meter equals 43,200 KW. Here the FSW is too large a value for a Kilowatt meter (the range is 000–2500). FSW for a Megawatt meter equals 043.2 MW. In FUNCTION 2, place the decimal after the third digit.

NOTE: In some applications where the load is normally very low, the watts resolution can be increased by moving the decimal point one position left.

To change the scale factor setting for wattage:

NOTE: Press **MAX/MIN/LIMITS** at any time to cancel before storing the last digit or switch.

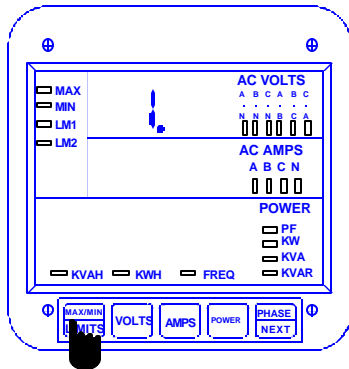

Step 1:

- a. Enter Group Level of Programming Mode (see Chp. 8).
- b. Press **MAX/MIN/LIMITS** until **1** appears in upper display.

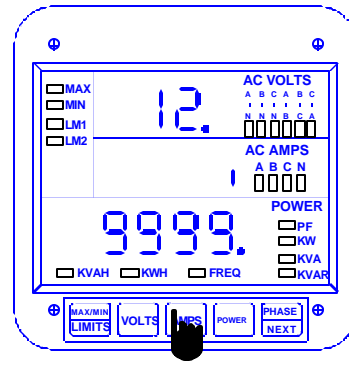

Step 2:

- a. Press **AMPS** to activate the Group.
- b. Press **MAX/MIN/LIMITS** until **12** appears in upper display.
 - ⇒ Middle display indicates current Scale Factor Setting.
 - ⇒ Lower display indicates **9999** (including current decimal placement).

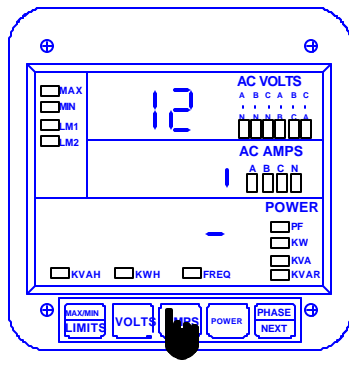

ENTERING THE SCALE FACTOR:

Step 3:

- a. Press **AMPS** to begin Data Entry Sequence.
 - ⇒ Lower display is replaced with a single dash.
- b. Press **VOLTS** to move the segment
 - ⇒ UP signifies - *megawatts*.
 - ⇒ DOWN signifies - *kilowatts*.
- c. Press **AMPS** to store.

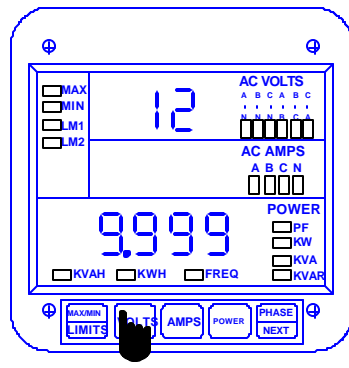

DECIMAL POINT SELECTION:

Step 4:

- ⇒ Display blanks and **9999** appears in lower display (including current decimal setting).
- a. Press **VOLTS** to move decimal.
- b. Press **AMPS** to store.
 - See Chapter 14 to Exit.

CHAPTER 11

PROGRAMMING GROUP 2—METER CALIBRATION

WARNING—READ THIS SECTION CAREFULLY BEFORE PROCEEDING:

- Any rescaling, such as a change in a transformer ratio, can be accomplished in GROUP 1. Calibration is not necessary.
- Meter calibration cannot be performed if the meter is installed for service. The sensing inputs must be connected to a power supply with variable voltage and separate current outputs.
- The calibration procedure requires highly accurate and stable input signals. Incorrect readings result from improper calibration procedures. If unsure, return unit to the factory for calibration.
- BEFORE calibrating any channel, make a note of its Full Scale Setting (see Chapter 10). Set the Full Scale in accordance with Table 10-2 for calibration. Restore original Full Scale Setting when calibration is completed.

11.1: Calibration Requirements

Calibration on the DMMS300+ requires precise inputs of 120 Volts, 5 Amps, and 2.5 Amps. The DMMS300+ -G model requires precise inputs of 300 Volts, 5 Amps, and 2.5 Amps. If this equipment is unavailable, contact us for assistance.

GROUP AND FUNCTION NUMBER	FUNCTION
20.	High End Calibration—Volts AN, BN, CN
21.	High End Calibration—Amps A, B, C
22.	Low End Calibration—Amps A, B, C
2E.	Exit Programming Group 2

Table 11-1: Group 2 Programming Format

NOTE: The voltage and current scales are calibrated with the maximum range value 2000 for current, 14.40 for voltage, 300 for option G. The calibration value can be identical to the full scale value in GROUP 1, for better accuracy than the specification. However, if a full scale is ever changed to a higher value than the calibrated value, the value may be less accurate.

VOLTAGE RANGE	INPUT SOURCE	GROUP 2 VALUE
69.3/120V	75V	1440
120/208V	120V L-N	1440
277/480V	300V	0300
5A CT High End	5A	2000
2.5A Low End	2.5A	1000

Table 11-2: Calibration Source, Full Scale and Value Settings for Calibration

11.2: Group 2, Functions 0–2—High End Calibration of Voltage Channels, High and Low End Calibration of Amperage Channels

To change the calibration (high end—Functions 0 and 1):

NOTE: Press **MAX/MIN/LIMITS** at any time to cancel before storing the last digit or switch.

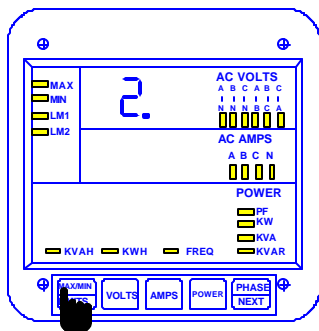

Step 1:

- Enter Group Level of Programming Mode (see Chp. 8).
 - Press **MAX/MIN/LIMITS** until **2** appears in upper display.
 - Press **AMPS** to activate the Group.
- ⇒ A one-digit password is required to continue.
- Press **VOLTS** until **5** appears.
 - Press **AMPS** to select.

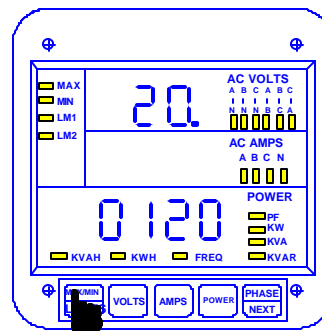

Step 2:

- ⇒ Refer to **Table 11-1** for Function Number that corresponds to the area requiring calibration. Calibration for each area begins with A and then moves to B and C.
- Press **MAX/MIN/LIMITS** to change Function number.

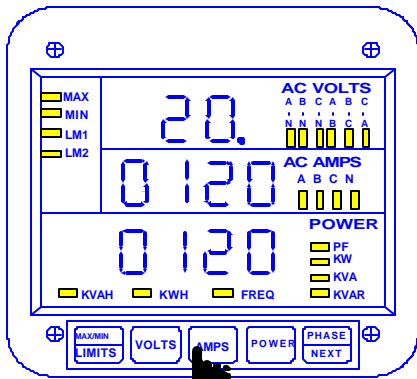

Step 3:

a. Press **AMPS** to activate calibration.

⇒ Digits move to middle display.

⇒ After a moment, digits appear in lower display also.

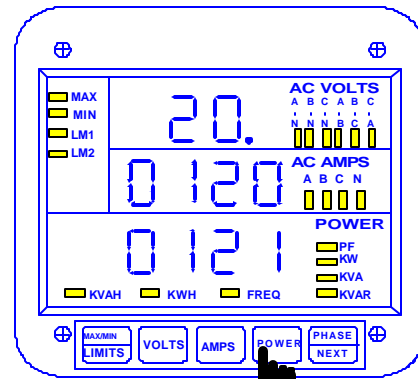

Step 4:

a. Press **POWER** to increase the value and **PHASE/NEXT** to decrease the value.

⇒ Digits in lower display disappear momentarily, then reappear indicating the new value.

b. Press **AMPS** to store and move to the next phase or Amp within the group.

See Chapter 14 to Exit.

For Amps Low End (Function 2):

NOTE: Press **MAX/MIN/LIMITS** at any time to cancel before storing the last digit or switch.

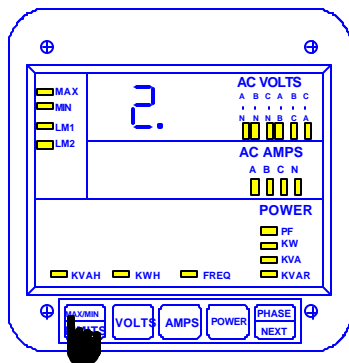

Step 1:

a. Enter Group Level of Programming Mode (see Chp. 8).

b. Press **MAX/MIN/LIMITS** until 2. appears in upper display.

c. Press **AMPS** to activate the Group.

⇒ A one digit password is required to continue.

d. Press **VOLTS** until 5 appears.

e. Press **AMPS** to select.

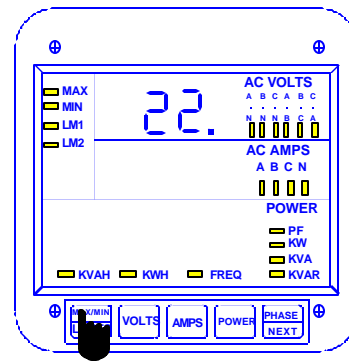

Step 2:

a. Press **MAX/MIN/LIMITS** until 22. appears in upper display.

b. Press **AMPS** to activate. (Calibration begins with Amps A, then moves to B and C).

⇒ Middle and lower displays blank.

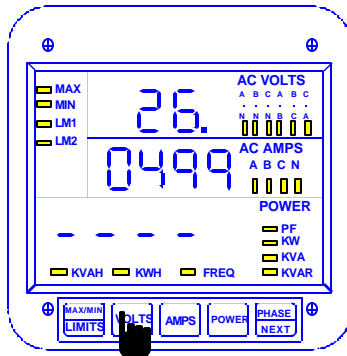

Step 3:

- ⇒ New value moves to middle display.
- ⇒ Lower display indicates the calibrated reading after 10-15 seconds.
- ⇒ To enter the half scale value in lower display,
 - a. Press **VOLTS** to select digits.
 - b. Press **AMPS** to store and proceed to B or C within the group.
 - c. Press **MAX/MIN/LIMITS** to end calibration procedure.

See Chapter 14 to Exit.

CHAPTER 12

GROUPS 4, 5 AND 6—SET LIMITS AND RELAYS

The DMMS300+ -NL offers a comprehensive limit and set point functionality. The user can program above or below limits for every reading, including %THD. When a voltage or current measurement exceeds a particular value, the set limit is triggered and alerts the user. Each limit can trigger two internal Form C dry contact relays for alarm or secondary protection.

The DMMS300+ offers two set limit points available for each measured function: LM1 and LM2. Each limit can be set at any desired level. Note: The DMMS425 does not have limit setting capability.

EXAMPLE OF LM1/LM2 SET LIMITS

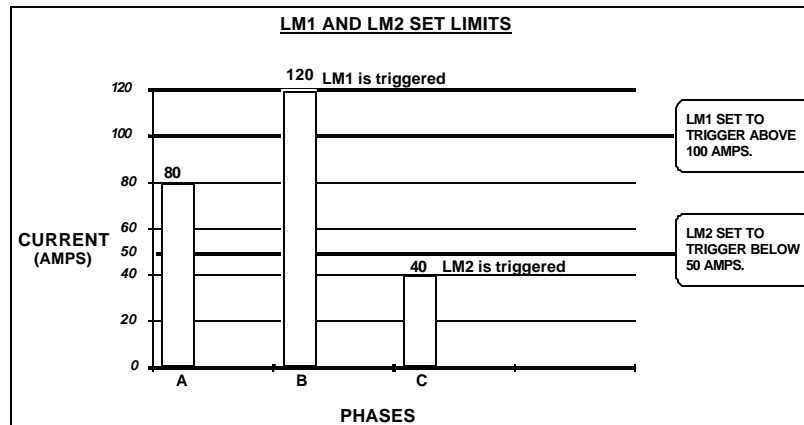

12.1: Trip Relay

The DMMS300+ -NL has two relays. These relays are linked through the program to Set Limits LM1 and LM2. The user can program above or below set limits for every reading. When a measurement exceeds a particular value, the set limit triggers and alerts the user. Each relay is programmed to a separate delay time (see Chp. 10).

12.2: Time Delays & Relay Mode

Time Delay indicates whether a delay exists in the relay changing position. Relay Mode indicates whether the relay will act as a protective switch or not.

NOTE: The Time Delay and Relay Mode are both located in GROUP 0, FUNCTIONS 4 & 5.

THE FOLLOWING GROUPS ALLOW THE USER TO PROGRAM LIMITS AND RELAYS:

GROUP 4: VOLTS/AMPS SET LIMITS / RELAYS

GROUP 4 contains LM1 and LM2 set limit values for voltage and amperage scales. This allows the user to program limits for the four following functions:

- 1) Volts phase-to-neutral
- 2) Volts phase-to-phase
- 3) Amps A, B, C
- 4) Amps neutral

12.3: Group 4, Functions 0–3—LM1/LM2 Set Limits

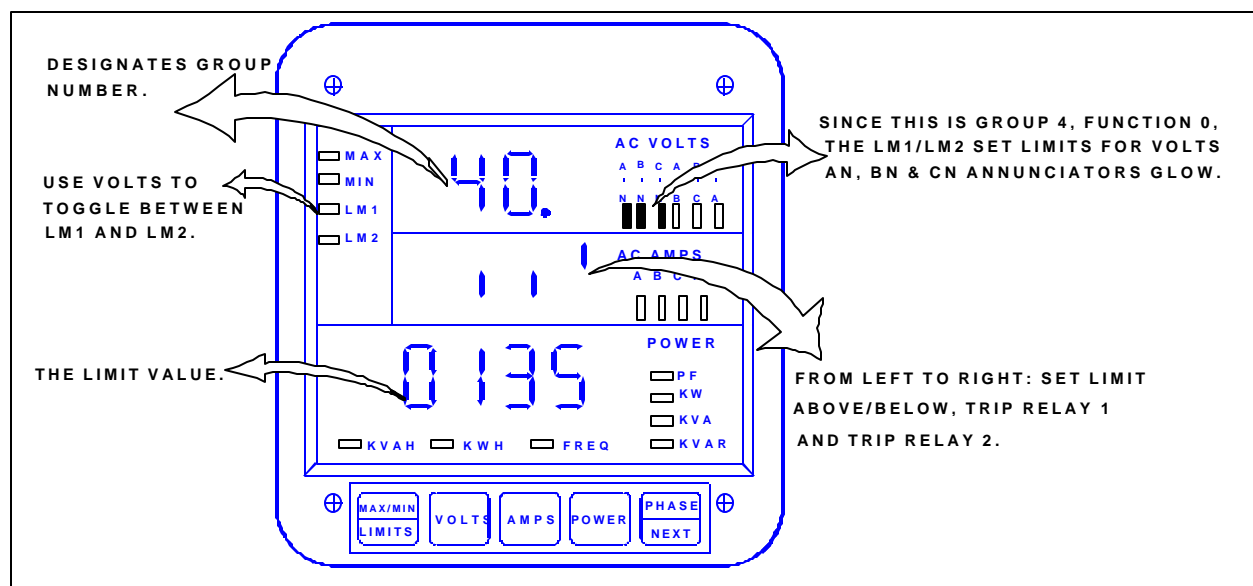

Group 4: Programming Format for Limit Condition

GROUP AND FUNCTION NUMBER	FUNCTION
40.	LM1/LM2 Set Limits for Volts AN, BN, CN
41.	LM1/LM2 Set Limits for Volts AB, BC, CA
42.	LM1/LM2 Set Limits for Amps A, B, C
43.	LM1/LM2 Set Limits for Amps Neutral
4E.	Exit Programming GROUP 4

Table 12.1: Group 4 Programming Format

NOTE: These functions have a two-part entry:

Part 1: The first switch sets the limit to trip either above or below the Limit Value.
 The second switch sets whether Relay 1 will trip when the condition occurs.
 The third switch sets whether Relay 2 will trip when the condition occurs.

Part 2: The second part is the Limit Value.

LM1 LED	LM2 LED	ABOVE/BELOW	RELAY 1	RELAY 2	VALUE
ON	OFF	Digit Up-trigger above value Digit Down-trigger below value	Digit Up-enabled Digit Down-disabled	Digit Up-enabled Digit Down-disabled	0-9999 0-9999
OFF	ON	Digit Up-trigger above value Digit Down-trigger below value	Digit Up-enabled Digit Down-disabled	Digit Up-enabled Digit Down-disabled	0-9999 0-9999

Table 12.2: Group 4: Functions 0–3

LM1 LED	LM2 LED	ABOVE/BELOW	RELAY 1	RELAY 2	VALUE
ON	OFF	Digit Up	Digit Up	Digit Down	0135
OFF	ON	Digit Down	Digit Down	Digit Up	0090

Table 12.3: Group 4: Example for Function 0

EXAMPLE: If voltages exceed 135 V, LM1 is triggered and Relay 1 is enabled. If the voltages fall below 90 V, LM2 is triggered and Relay 2 is enabled.

12.4: Group 5, Functions 0–7—LM1/LM2 Set Limits

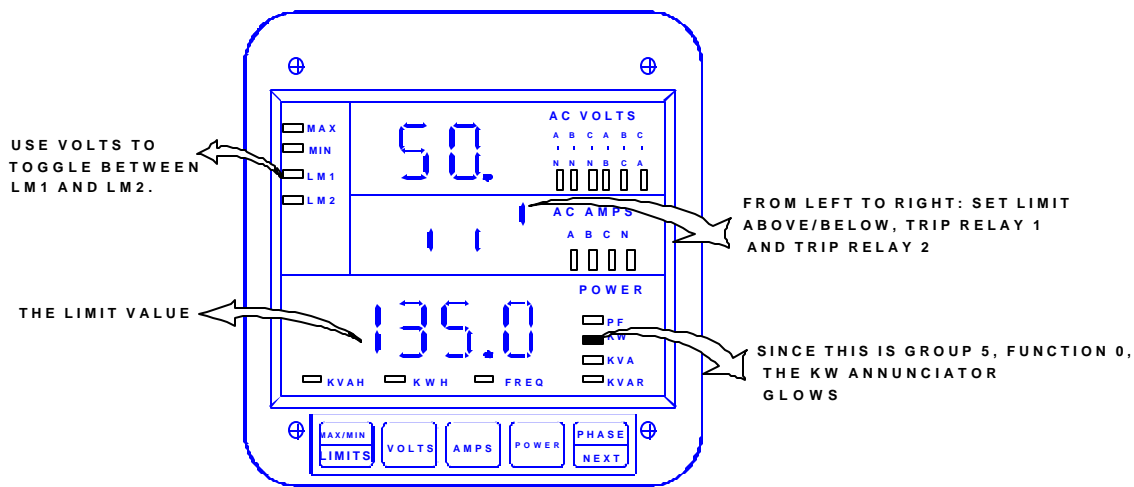

GROUP 5 contains LM1 and LM2 set limit values for all power functions. This allows the user to program limits for the following functions: Kilowatt, Kilovar, Kilovolt-ampere, Power Factor, Frequency, negative Kilovar, negative Power Factor, and negative Kilowatt.

GROUP AND FUNCTION NUMBER	FUNCTION
50.	LM1/LM2 Set Limits for Kilowatt
51.	LM1/LM2 Set Limits for Kilovar
52.	LM1/LM2 Set Limits for Kilovolt-ampere
53.	LM1/LM2 Set Limits for Power Factor
54.	LM1/LM2 Set Limits for Frequency
55.	LM1/LM2 Set Limits for Negative Kilovar
56.	LM1/LM2 Set Limits Negative Power Factor
57.	LM1/LM2 Set Limits for Negative Kilowatt
5E.	Exit Programming GROUP 5

Table 12.4: Group 5 Programming Format for Limit Condition

THERE ARE 3 SWITCHES TO SET WITH LIMITS:

- 1) Switch 1: Sets the limit to trip either above or below the Limit Value.
- 2) Switch 2: Sets whether Relay 1 will trip when the condition occurs.
- 3) Switch 3: Sets whether Relay 2 will trip when the condition occurs.

After the switches are set, the limit value should be programmed (see table in section 12.4).

LM1 LED	LM2 LED	SWITCH 1 ABOVE/BELOW	SWITCH 2 RELAY 1	SWITCH 3 RELAY 2	VALUE
ON	OFF	Digit Up-trigger above value Digit Down-trigger below value	Digit Up-enabled Digit Down-disabled	Digit Up-enabled Digit Down-disabled	0-9999 0-9999
OFF	ON	Digit Up-trigger above value Digit Down-trigger below value	Digit Up-enabled Digit Down-disabled	Digit Up-enabled Digit Down-disabled	0-9999 0-9999

Table 12.5: Group 5: Functions 0–7

LM1	LM2	SWITCH 1	SWITCH 2	SWITCH 3	VALUE
ON	OFF	Digit Up	Digit Up	Digit Down	0120
OFF	ON	Digit Down	Digit Down	Digit Up	0090

Table 12.6: Group 5: Example for Function 0

Thus, if Kilowatts exceed 120 W, LM1 is triggered and Relay 1 is tripped. If the Kilowatts fall below 90 W, LM2 is triggered and Relay 2 is tripped.

SPECIAL CASES

FREQUENCY: FUNCTION 4 contains a permanent decimal after the *second* digit. The highest and lowest level limits that can be programmed are **99.99** and **00.00**, respectively.

POWER FACTOR: FUNCTIONS 3 and 6 contain a permanent decimal after the *first* digit. The highest and lowest limits that can be programmed are **1.000** and **0.000**, respectively.

Programming Group 6, LM1/LM2 Set Limits

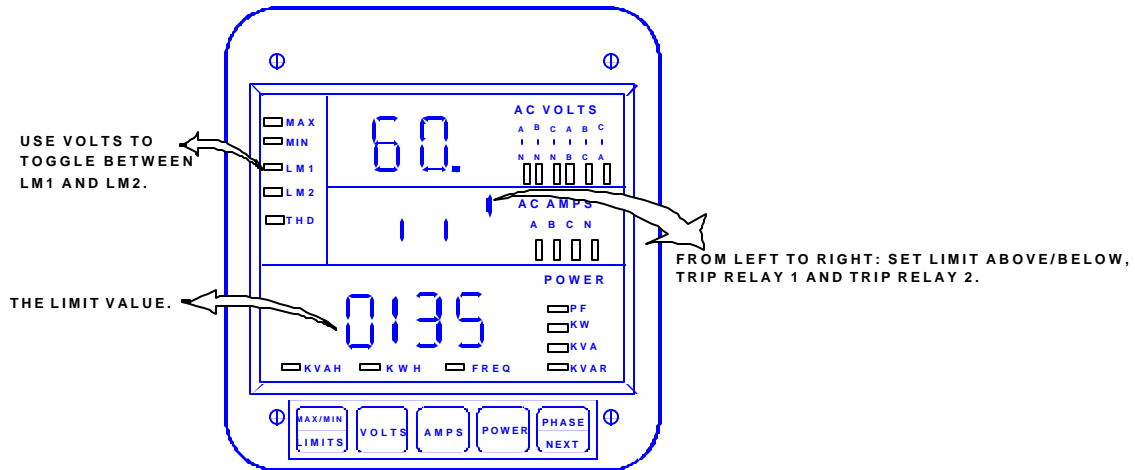

GROUP 6: THD SET LIMITS / RELAYS (For Option -H)

GROUP 6 contains LM1 and LM2 set limits for THD. These allows the user to program limits for the following functions: THD Volts AN, BN, CN, Amps A, Amps B, and Amps C.

GROUP AND FUNCTION NUMBER	FUNCTION
60.	THD Volts AN
61.	THD Volts BN
62.	THD Volts CN
63.	THD Amps A
64.	THD Amps B
65.	THD Amps C
6E.	Exit Programming GROUP 6

Table 12.7: Group 6 Programming Format For THD Limit Conditions

LM1 LED	LM2 LED	SWITCH 1 ABOVE/BELOW	SWITCH 2 RELAY 1	SWITCH 3 RELAY 2	VALUE
ON	OFF	Digit Up-trigger above level Digit Down-trigger below level	Digit Up-enabled Digit Down-disabled	Digit Up-enabled Digit Down-disabled	0-999.9 0-999.9
OFF	ON	Digit Up-trigger above level Digit Down-trigger below level	Digit Up-enabled Digit Down-disabled	Digit Up-enabled Digit Down-disabled	0-999.9 0-999.9

Table 12.8: Group 6 Functions 0-5

12.5: Group 6, Functions 0–5—LM1/LM2 Set Limits and Relay Triggers for Over/Under %THD Conditions

LM1 LED	LM2 LED	SWITCH 1 ABOVE/BELOW	SWITCH 2 RELAY 1	SWITCH 3 RELAY 2	LEVEL
ON	OFF	Digit Up	Digit Up	Digit Down	012.0
OFF	ON	Digit Down	Digit Down	Digit Up	009.0

Table 12.9: Group 6—Example for Function 0

So, if THD exceeds 12%, LM1 is triggered and Relay 1 is enabled.

If THD falls below 9%, LM2 is triggered and Relay 2 is enabled.

12.6: Limits or Relays Programming Procedure

NOTE: The procedure for programming any limit or relay for each group is identical. The example below signifies the exact procedure for programming a Limit/Relay for GROUPS 4-6.

—Group 4 is used as an example.

NOTE: Press **MAX/MIN/LIMITS** at any time to cancel before storing the last digit or switch.

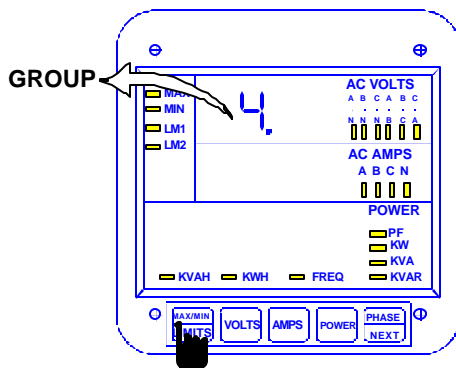

Step 1:

- Enter Group Level of Programming Mode (see Chp. 8).
- Press **MAX/MIN/LIMITS** until **4** appears in upper display.
- Press **AMPS** to activate the Group.

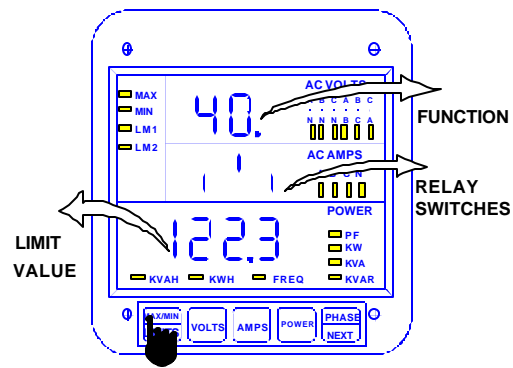

Step 2:

- Press **MAX/MIN/LIMITS** to select desired Function.

⇒ Middle display provides the currently selected value for whether to trip *above* or *below*, activate Relay 1 and activate Relay 2.

Left Switch: UP position indicates above tripping value for lower display's value. DOWN position indicates below tripping.

Middle Switch: UP position sets Relay 1 to trip.

DOWN position doesn't activate Relay 1 when limit condition exists.

Right Switch: Same as Middle Switch, regarding Relay 2.

- Press **VOLTS** to toggle between LM1 and LM2 settings.

⇒ The LM1 or LM2 annunciator indicates the limit being displayed.

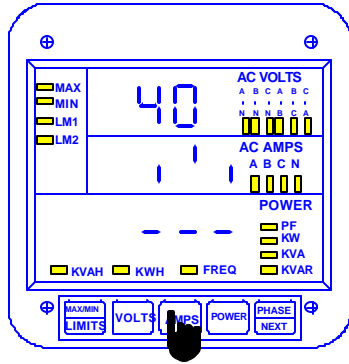

Step 3:

a. Press **AMPS** once.

⇒ Lower display is replaced with three dashes.

⇒ Follow this step for **DISABLING LIMITS**:

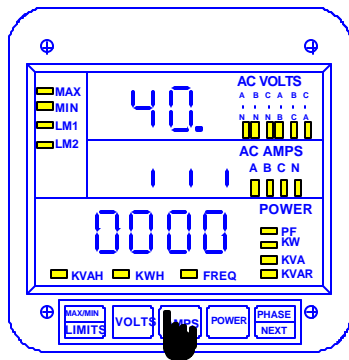

Step 4:

a. Press **AMPS** once to Disable the Limit.

⇒ The display blanks momentarily, then the disabled settings appears in middle and lower displays.

⇒ The *Set Above/Below* will be set to below.

⇒ *Trip Relay 1* will be disabled.

⇒ *Trip Relay 2* will be disabled.

⇒ The *Setup Level* will be set to 0000.

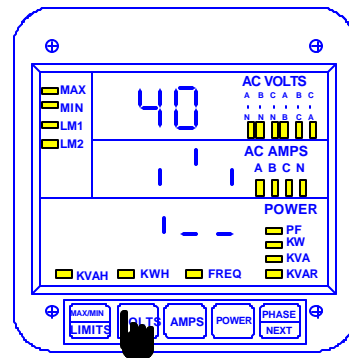

Step 5:

a. Press **VOLTS** to change current Set Above/Below, Trip Relay 1, and Trip Relay 2 settings.

⇒ This toggles the segments UP (above limit) or DOWN (below limit).

b. Press **AMPS** to store.

c. Press **VOLTS** to toggle the second segment UP (enable Relay 1) or DOWN (disable Relay 1).

d. Press **AMPS** to store.

e. Press **MAX/MIN/LIMITS** to proceed to entering the limit value.

f. Press **AMPS** to store.

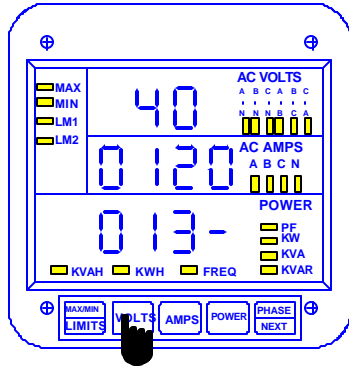

Step 6:

- a. Press **VOLTS** to scroll through digits.
- b. Press **AMPS** to select.
- c. At the last digit, press **AMPS** twice to store limit programming.

⇒ Wait 3 seconds and the display updates with the new programming value.

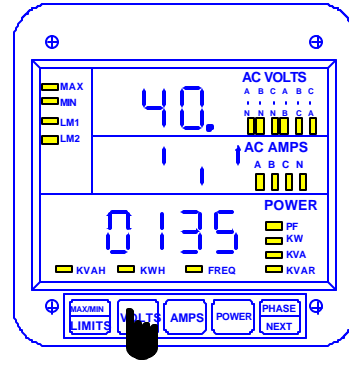

Step 7:

- a. Press **VOLTS** to program the other limits and repeat this procedure.
- b. Press **MAX/MIN/LIMITS** TO PROGRAM ANOTHER Function (refer to Step 2).

See Chapter 14 to Exit.

CHAPTER 13

PHASE REVERSAL AND PHASE IMBALANCE SET LIMITS/RELAYS

13.1: Phase Reversal and Phase Imbalance

The set limit alerts the user of an unbalanced or a reversed phase in a Three-phase System. The DMMS300+ has two options for this purpose. The standard set-up is clockwise ABC rotation. Counterclockwise CBA rotation can be selected in GROUP 03.1, Switch C UP.

PHASE REVERSAL: Activates when a reversed phase enters the DMMS300+'s metering system.

PERCENT PHASE IMBALANCE: Activates when the user's preset value percent phase imbalance is exceeded. For example: an unbalanced Three-phase System.

Note: The DMMS425 does not have this capability.

FIGURE 13-1: EXAMPLE OF SET LIMITS

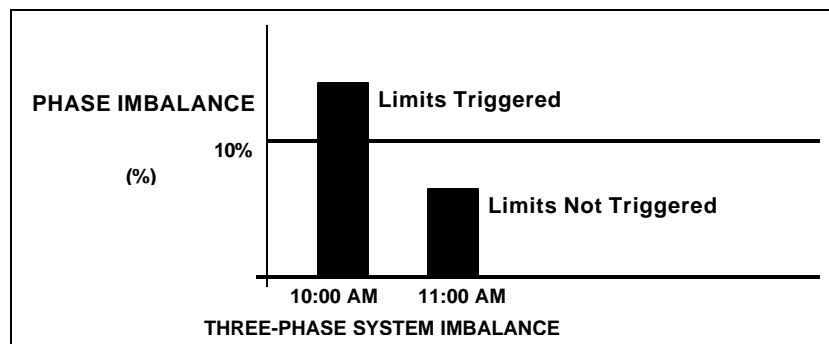

13.2: Trip Relay

NOTE: All information pertaining to Trip Relays 1 and 2 applies only to a meter with the -NL option.

The unit has two relays linked through the program to LM1 and LM2 Set Limits. The relay outputs can be programmed individually to close when LM1 and/or LM2 is triggered. Each relay has provisions for a separate delay (see Chapter 12).

- ① **TRIP RELAY 1** Whether to trip Relay 1.
- ② **TRIP RELAY 2** Whether to trip Relay 2.
- ③ **LEVEL** The level at which the warning mechanism trips percentage of voltage imbalance.
- ④ **ENABLE/DISABLE** In the event of Phase Reversal, whether to enable or disable Phase Reversal Detection.

13.3: Group 7, Function 0—Voltage Phase Reversal Detection

GROUP AND FUNCTION NUMBER	FUNCTION
70.	Voltage Phase Reversal Detection
71.	Voltage Phase Imbalance
7E.	Exit Programming GROUP 7

Table 13.1: Group 7 Programming Format

To change the phase reversal setting:

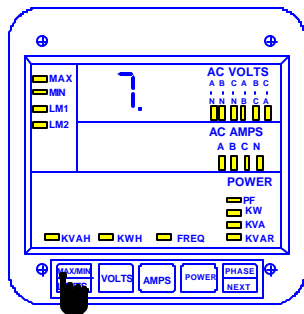

Step 1:

- Enter Group Level of Programming Mode (see Chp. 8).
- Press **MAX/MIN/LIMITS** until **7.** appears in upper display.
- Press **AMPS** to activate the Group.

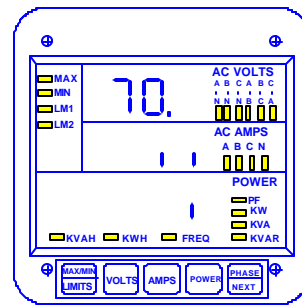

- ⇒ **70.** appears in upper display.
- ⇒ Middle display indicates current settings for Trip Relay 1 and Trip Relay 2.
- ⇒ Lower display indicates current setting for Enable/Disable Phase Reversal Detection.

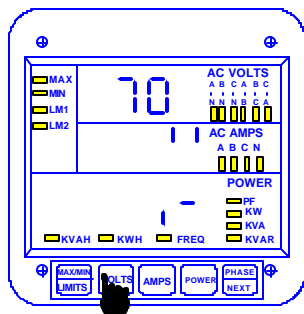

Step 2:

- Press **AMPS** once.
 - ⇒ Lower display is replaced with two dashes.
- Press **VOLTS** to toggle the first segment UP (enable Relay 1) or DOWN (disable Relay 1).
- Press **AMPS** to select. (Repeat procedure for second segment-Relay 2).

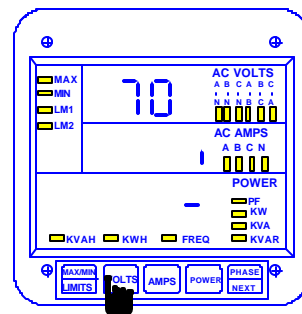

Step 3:

- ⇒ Middle display is replaced with current Phase Reversal Setting.
 - ⇒ Lower display is replaced with a single dash.
- Press **VOLTS** to toggle the segment UP (enable Phase Reversal Detection) or DOWN (disable detection).
 - Press **AMPS** to store.

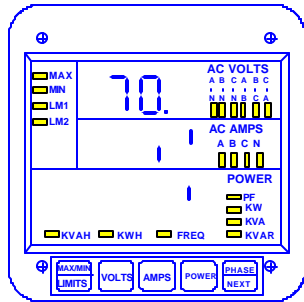

⇒ Middle and Lower display indicate FUNCTION 0 settings.

See Chapter 14 to exit.

13.4: Group 7, Function 1—Percentage Voltage Phase Imbalance

To change the percentage voltage phase imbalance:

NOTE: Press **MAX/MIN/LIMITS** at any time to cancel before storing the last digit or switch.

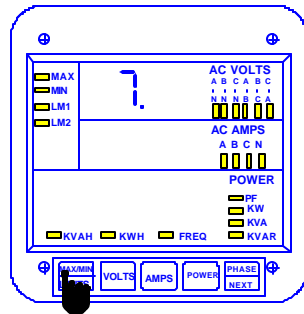

- Step 1:**
- Enter Group Level of Programming Mode (see Chp. 9).
 - Press **MAX/MIN/LIMITS** until **7.** appears in upper display.
 - Press **AMPS** to activate the Group.

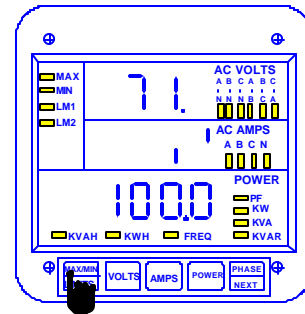

- Step 2:**
- Press **MAX/MIN/LIMITS** until **71.** appears in upper display.
 - ⇒ Middle display indicates the Trip Relay 1 and Trip Relay 2 settings.
 - ⇒ Lower display indicates the percentage of Voltage Phase Imbalance.

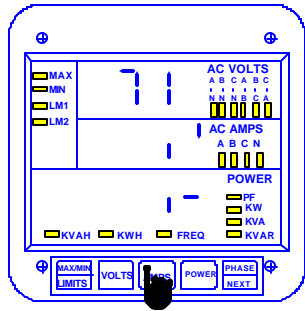

Step 3:

- a. Press **AMPS** to begin Data Entry Sequence.
- ⇒ Lower display is replaced with two dashes.
- b. Press **VOLTS** to toggle the first segment UP (enable Relay 1) or DOWN (disable Relay 1).
- c. Press **AMPS** to store.

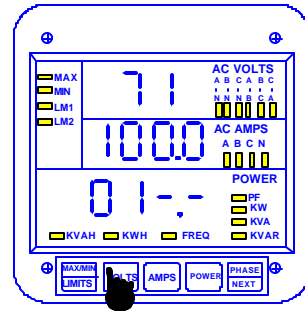

Step 4:

- ⇒ Middle display indicates the current percentage of Voltage Phase Imbalance.
- ⇒ Four dashes appear in lower display.
- a. Press **VOLTS** to scroll through digits.
- b. Press **AMPS** to select desired digit.

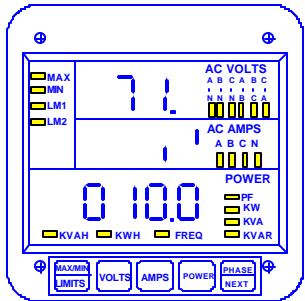

⇒ Middle and lower displays indicate new settings.

See Chapter 14 to Exit.

CHAPTER 14

EXITING PROGRAMMING MODE

NOTE: Steps to exit Programming Mode vary depending on the programming stage.

Exiting the Programming Mode is **always** necessary to store any new changes and to calculate a new checksum. Failure to exit results in a checksum error: the display blanks and the max LED flashes.

IF YOU ARE LOCATED IN A FUNCTION Level—begin at **Step 1**.

IF YOU ARE LOCATED IN A GROUP Level—begin at **Step 2**.

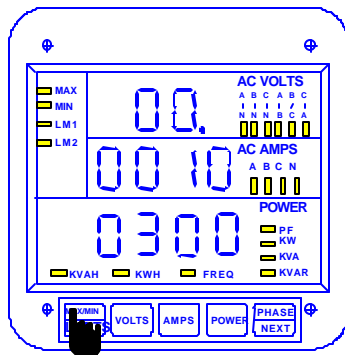

Step 1: EXITING FROM FUNCTION LEVEL

- Press **MAX/MIN/LIMITS** until the Group number in upper display is followed by **E** (for Exit).

⇒ The meter returns to Function Level.

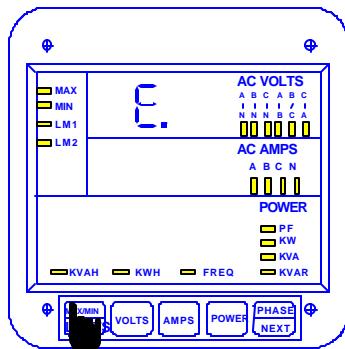

Step 2: EXITING FROM GROUP LEVEL

- Press **MAX/MIN/LIMITS** until **E.** appears in upper display (for Exit).
- Press **AMPS** to exit entirely from Programming Mode.

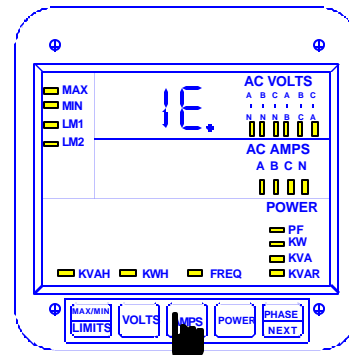

Step 1a.:

- Press **AMPS** to exit from Function Level to Group Level.

CHAPTER 15

PROGRAMMING QUICK REFERENCE

15.1: Entering the Programming Mode

1. Hold **PHASE/NEXT** key and press **AMPS** key.
2. Display blanks and shows either a '0', '1', or '3'.
3. If '3' is not displayed then press **AMPS** key until '3' is displayed.
4. Release **AMPS** key and press **PHASE/NEXT** key, while '3' is still displayed.
5. Display shows '333' momentarily.
6. Upper display starts counting. Press **PHASE/NEXT** key when '5' is displayed to register the '5'.
7. Repeat step 6 until '555' has been registered.

15.2: Data Entry Sequence

1. At programmable numerical fields or Switch Pack fields, Press **AMPS** key to begin Data Entry Sequence.
2. The current setting moves to middle row of display and dashes appear in the bottom row. Press **VOLTS** key to toggle between available choices.
3. When a correct choice is selected, press **AMPS** key to store.

15.3: Programming Groups

Programming groups	Description
0	Global Meter Setup—Integration Interval, Meter Address, Communication Setting, Relay Settings
1	Full Scale Settings. Voltage Full Scale, Current Full Scale and Power Function Full Scale.
2	Meter Calibration
3	Calibration Ratios
4	Volts and Current Limits
5	Power Function Limits
6	THD Limits
7	Imbalance Reversal Limits
8	DC Output Calibration

15.4: Group 0—Global Meter Setup

- 00. Interval.
- 01. Meter Address for Communication.
- 02. Baud Rate for Communication.
- 03. System Configuration Switch Packs.
 - 030. *Reserved Switches.*
 - 031.
 - A. Blank Non Significant Leading Zeros
 - B. Reset Protection
 - C. Phase Reversal Rotation Selection
 - D. Open Delta Configuration
 - 032.
 - A. Instantaneous/Average Limit
 - B. Power Factor Polarity
 - C. Modbus Options
 - D. Protocol Selection
 - 033.
 - A. Computer Control Relay 1
 - B. Computer Control Relay 2
 - C. Communication Selection
 - D. DC-Output/Print Control
- 04. Relay 1 Programming
 - 04P.
 - A. Imb/Rev Selection
 - B. And/or Logic
 - C & D. Relay Control Selection
 - 040. ON to OFF delay time
 - 041. OFF to ON delay time
- 05. Relay 2 Programming 05P.
 - A. Imb/Rev Selection
 - B. *Reserved*
 - C. & D. Relay Mode Selection
- 050. ON to OFF delay time
- 051. OFF to ON delay time

- 06. KYZ Programming
 - 06P. Pulse Factor Programming
 - 060. KYZ Port 0 Function Mapping
 - 061. KYZ Port 1 Function Mapping
 - 062. KYZ Port 2 Function Mapping
- 07. Number of Phases

15.5: Group 1: Full Scale Setup

- 10. Volts Full Scale
- 11. Currents Full Scale
- 12. Power Full Scale

15.6: Group 2: Calibration

- 20. Volt AN, BN, CN
- 21. Amp A, B, C (High End)
- 22. Amp A, B, C (Low End)

15.7: Group 3: Calibration Ratios

- 30. Volt AN
- 31. Volt BN
- 32. Volt CN
- 33. Amp A (High-End Ratios)
- 34. Amp B (High-End Ratios)
- 35. Amp C (High-End Ratios)
- 36. Amp A (Low-End Ratios)
- 37. Amp B (Low-End Ratios)
- 38. Amp C (Low-End Ratios)

15.8: Group 4: Volt/Current Limits

- 40. Volt AN, Volt BN, and Volt CN Limits.
- 41. Volt AB, Volt BC, and Volt CA Limits.
- 42. Amp A, Amp B, and Amp C Limits.
- 43. Amp N Limits.

15.9: Group 5: Power Function Limits

- 50. +Watt Limits
- 51. +VAR Limits
- 52. VA Limits
- 53. +PF Limits
- 54. Frequency Limits
- 55. -VAR Limits
- 56. -PF Limits
- 57. -Watt Limits

15.10: Group 6: THD Limits

- 60. Volt AN THD Limits
- 61. Volt BN THD Limits
- 62. Volt CN THD Limits
- 63. Amp A THD Limits
- 64. Amp B THD Limits
- 65. Amp C THD Limits

15.11: Group 7: Imbalance/Reversal Limits

- 70. Detect Reversal
- 71. Imbalance percent Limit

15.12: Group 8: DC output Calibration

8P. Switch Packs

8P0.

- A. 75 Volts Suffix Selection
- B. 300 Volts Suffix Selection
- C. Frequency
- D. 10 Channel Selection

8P1. Power Uni/Bi Directional Selection

- A. Port 0
- B. Port 1
- C. Port 2
- D. Port 3

8P2. Power Uni/Bi Directional Selection

- A. Port 4
- B. Port 5
- C. Port 6
- D. Port 7

8P3. Power Uni/Bi Directional Selection

- A. Port 8
- B. Port 9
- C. *Reserved*
- D. *Reserved*

80. DC output Port 0

- 80F. Parameter Mapping
- 80L. Low-End Calibration
- 80H. High-End Calibration

81. DC output Port 1

- 81F. Parameter Mapping
- 81L. Low-End Calibration
- 81H. High-End Calibration

89. DC output Port 9

- 89F. Parameter Mapping
- 89L. Low-End Calibration
- 89H. High-End Calibration

KEY DESIGNATIONS

MAX/MIN/LIMITS — Scroll Groups
— Scroll Functions

VOLTS — Scroll Packs

AMPS — Enter/Exit Group
— Enter/Exit

CHAPTER 16

ETHERNET OPTION

The DMMS350 Meter with the Ethernet Option has all the components of the standard Meter PLUS the capability of connecting to multiple devices over Ethernet. The Meter face is the same as the DMMS300+.



16.1: Ethernet Module

The Ethernet connection is made with a small module added to the back of the meter. This small but powerful module has simply an RJ-45 Port and four Status LEDs.

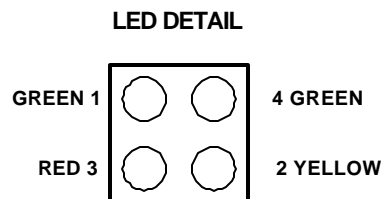
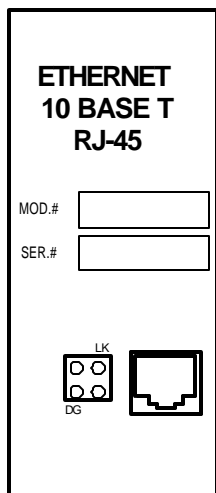

See the Table below for a description of the Status LED functions.

LED	Description	LED Functions
1	Serial Port (Channel) 1 Status	Lights solid green to indicate Channel 1 is IDLE. Blinks green to indicate Channel 1 is connected to the network and ACTIVE.
2	Serial Port (Channel) 2 Status	Lights solid yellow to indicate Channel 2 is IDLE. Blinks yellow to indicate Channel 2 is connected to the network and ACTIVE. (Not used by this device; reserved for future use)
3	Diagnostics	Blinks or lights solid red in combination with the green (Channel 1) LED to indicate DIAGNOSTICS and ERROR DETECTION. Red solid, green (Channel 1) blinking: 1x: EPROM checksum error 2x: RAM error 3x: Network controller error 4x: EEPROM checksum error 5x: Duplicated IP address on network* 6x: Software does not match hardware* Red blinking, green (Channel 1) blinking: 4x: Faulty network connection* 5x: No DHCP response received*
4	Network Link Status	Lights solid green to indicate network port is connected to the network.
		* non-fatal error

16.2: Ethernet Option Setup

This chapter covers the required steps to get the Ethernet Interface on-line and working. There is only one method used to log into the Ethernet Server and set up the IP address:

- Network Port Login: make a Telnet connection to the network port (9999).

It is important to consider the following points before logging into and configuring the Ethernet Interface:

- The Ethernet Interface's IP address must be configured before a network connection is available.
- Only one person at a time may be logged into the network port. This eliminates the possibility of several people trying to configure the Ethernet Interface simultaneously.

16.3: Default IP Address

The Ethernet Interface ships with a default IP address set to 0.0.0.0, which automatically enables DHCP within the Ethernet Interface.

Provided a DHCP server exists on the network, it will supply the Ethernet Interface with an IP address, gateway address and subnet mask when the Ethernet Interface boots up. If not DHCP server exists, the Ethernet Interface will respond with a diagnostic error: the RED Diagnostic LED blinks continuously and the GREEN Status LED blinks five times.

16.4: AutoIP

Auto IP allows an Ethernet Interface to obtain an address in a network that does not have a DHCP server. (Windows 98 and 2000 also support AutoIP.)

AutoIP assigns a random valid address to the Ethernet Interface in the range of 169.254.x.1 to 169.254.x.1 (x can be between 0 and 255). This range of IP addresses is not to be used over the Internet. If the Ethernet Interface has not been configured manually and cannot find a DHCP server, it automatically chooses an address from the reserved range. The Ethernet Interface then uses the Address Resolution Protocol (ARP) to send out a request asking if any node is using that address. If another node is using the same address, the Ethernet Interface assigns another IP address, reboots and repeats the sequence.

NOTE: AutoIP-enabled Ethernet Interfaces are constantly looking for DHCP servers. If a DHCP server becomes available on the network, the AutoIP-enabled Ethernet Interface switches to the DHCP server-provided address and the unit reboots. If the DHCP server exists but denies the Ethernet Interface an IP address, the Ethernet Interface does not attach to the network, but waits and retries.

AutoIP allows a small network of AutoIP-enabled devices to be set up without any need for a DHCP server or static IP addresses.

AutoIP can be disabled by setting the IP address to 0.0.1.0. The 1 in the third octet is the disabling factor.

16.5: Setting the IP Address

The Ethernet Interface's IP address must be configured before a network connection is available. If the IP address was not set automatically via DHCP, set it now using a network and the setup (configuration) menu.

NETWORK PORT LOGIN

The ARP method is available under UNIX and Windows-based systems. The Ethernet Interface will set its address from the first directed TCP/IP packet it receives.

ARP ON UNIX

On a Unix host, create an entry in the host's ARP table using the intended IP address and the hardware address of the Ethernet Interface, which is found on the product label.

```
arp -s 191.12.3.77 00:20:4a:xx:xx:xx
```

ARP ON WINDOWS

In order for the ARP command to work on Windows, the RP table on the PC must have at least one IP address defined other than its own. If the ARP table is empty, the command will return an error message. Type ARP -A at the DOS command prompt to verify that there is at least one entry in the ARP table.

If the local machine is the only entry, ping another IP address on your network to build a new entry in the ARP table; the IP address must be a host other than the machine on which you are working. Once there is at least one additional entry in the ARP table, use the following command to ARP the IP address to the Ethernet Interface:

```
arp -s 191.12.3.77 00-20-4a-xx-xx-xx
```

TELNET TO PORT 1

Now open a Telnet connection to Port 1. The connection will fail quickly (3 seconds). But the Ethernet Interface will temporarily change its IP address to the one designated in this step.

```
telnet 191.12.3.77 1
```

TELNET TO PORT 9999

Finally, open a Telnet connection to port 9999 and set all required parameters.

```
telnet 191.12.3.77 9999
```

NOTE: This IP address is temporary and will revert to the default value when the Ethernet Interface's power is reset, unless you log into the Ethernet Interface and store the changes permanently.

16.6: Network Configuration

Certain parameters must be configured before the Ethernet Interface can function on a network. The Ethernet Interface can be locally or remotely configured using the following procedures:

Use a Telnet connection to configure the unit over the network. The Ethernet Interface's configuration is stored in nonvolatile memory (NVRam) and is retained without power. The configuration can be changed at any time. The Ethernet Interface performs a reset after the configuration has been changed and stored.

As mentioned above, to configure the Ethernet Interface over the network, establish a Telnet connection to port 9999. From the Windows Start menu, click Run and type the following command, where x.x.x.x is the IP address and 9999 is the Ethernet Interface's fixed network configuration port number.

```
telnet x.x.x.x 9999
```

NOTE: Be sure to include a space between the IP address and 9999.

16.7: Configuration Parameters

After entering Setup Mode (confirm by pressing Enter), you can configure the parameters by entering one of the numbers on the Change Setup Menu, or you can confirm default values by pressing **Enter**. Be sure to store new configurations when you are finished. The Ethernet Interface will then perform a power reset.

Serial Number 5415404 MAC Address 00:20:4A:54:3C:2C
Software Version V01.2 (000719)
Press Enter to go into Setup Mode

- 1) Network/IP Settings:
 - Ethernet Interface Autodetect
 - IP Address - 0.0.0.0/DHCP (Customer Configurable)
 - Default Gateway --- not set --- (Customer Configurable)
 - Netmask --- not set --- (Customer Configurable)
- 2) Serial & Mode Settings:
 - Protocol Modbus/RTU, Slave(s) attached (FIXED)
 - Serial Interface 9600,8,N,1,RS232,DB25 (must match meter) (FIXED)
- 3) Modem Control Settings:
 - DCD Output Fixed High/Active
 - CTS Output Fixed High Active
- 4) Advanced Modbus Protocol Settings:
 - Slave Addr/Unit Id Source Modbus/TCP header (FIXED)
 - Modbus Serial Broadcasts Disabled
 - Character, Message Timeout 00010 ms, 00500 ms

D) default settings, S) save, Q) quit without save;
select command or parameter set (1..4) to change: I

BAUD RATE

The Ethernet Interface and attached serial device (the meter) must agree on a speed or baud rate used for the serial connection. Valid baud rates are 1200, 2400, 4800 and 9600 (default). For the DMMS350, default settings are **9600 baud rate, 8 data, 1 stop, no parity, Modbus RTU**.